

Operating manual for micro annular gear pumps
mzr-2961, mzr-4661



HNP Mikrosysteme GmbH
Bleicherufer 25
D-19053 Schwerin (Germany)
Telephone: +49 385/52190-301
Telefax: +49 385/52190-333
E-mail: info@hnp-mikrosysteme.de
<http://www.hnp-mikrosysteme.de>

Last update: April 2018

Impressum

Original instructions

Copyright

HNP Mikrosysteme GmbH
Bleicherufer 25
D-19053 Schwerin

All rights, including translation, reserved.

Without prior explicit written permission of HNP Mikrosysteme GmbH no part of this manual may be, copied, reproduced or processed.

This manual has been prepared with care. HNP Mikrosysteme does assume no liability for any errors in this manual and resulting consequences. Likewise, no liability is assumed direct or subsequent damages arising from an incorrect use of the devices.

While using micro annular gear pumps, the relevant standards regarding the specifications of this manual have to be followed.

Subject to change without notice.

Contents

1	General Information	1
1.1	Application scope of the pumps	1
1.2	Product information	2
1.3	Measurements	2
1.4	Flow chart	3
1.5	Technical data of the micro annular gear pumps	4
1.6	Technical data of the drive	5
2	Safety instructions	7
2.1	Safety symbols in this operating manual	7
2.2	Staff qualification and training	7
2.3	Safety-conscious work	7
2.4	Safety instructions for the operator	8
2.5	Safety instructions for maintenance, check and assembly of the pump	8
2.6	Unauthorized pump conversions and spare part manufacture	8
2.7	Improper modes of operation	9
2.8	General safety instructions	9
3	Transport and intermediate storage	10
3.1	Shipment of the pumps and protection measures	10
3.2	Transport	10
3.3	Intermediate storage	10
4	Description of the pump	11
4.1	Principle of the Micro annular gear pumps	11
4.2	Micro annular gear pump	13
4.3	Materials and liquids	14
4.4	Liquid supply	14
5	Optional modules	16
5.1	By-pass module (optional)	17
6	System integration	19
6.1	Checkup before the first assembly	19
6.2	Mounting of the micro annular gear pump	19
6.3	General instructions for the assembly of the liquid supply network	20
6.4	Filter selection and use	21
6.5	Operation with terminal box S-G61	22
7	Start Up / Shut Down	26
7.1	Preparing for operation	26
7.2	Startup of the micro annular gear pump	26
7.3	Flushing procedure after use	26

7.4	Shutdown of the micro annular gear pump	29
7.4.1	Conservation	31
7.4.2	Dismantling of the system	32
7.5	Trouble shooting	33
7.6	Return of the micro annular gear pump to the manufacturer	33
8	Accessories for microfluidic systems	34
9	Non-liability clause	34
10	Problems and their removal	35
11	EC Directive	38
11.1	Electromagnetic Compatibility (EMC)	39
11.1.1	EMC Directive and Standards	39
11.1.2	Information on use as intended	40
12	Declarations of conformity	42
13	Service, maintenance and warranty	47
14	Contact person	48
15	Legal information	49
16	Safety information for the return of already employed micro annular gear pumps and components	50
16.1	General information	50
16.2	Declaration of media in contact with the micro annular gear pump	50
16.3	Shipment	50
17	Declaration of media in contact with the micro annular gear pump and its components	51
18	Appendix	52

1 General Information

This operation manual contains basic instructions to be followed during integration, operation and maintenance of the m zr® micro annular gear pump. For this reason it is necessary to read it carefully before any handling of the device. The present manual should always be kept at the operation site of the micro annular gear pump.

In case assistance is needed, please indicate the pump type visible on the housing.

1.1 Application scope of the pumps

The micro annular gear pumps m zr-2961 and m zr-4661 described in this manual are suitable for continuous delivery of water, watery solutions, solvents, methanol and varnishes as well as many other liquids.



If you intend to handle any aggressive, poisonous or radioactive liquids, you must conform to safety measures as according to the regulations in force. Any project concerning handling of corrosive liquids should be previously discussed with the pump manufacturer.



The micro annular gear pumps should not be used for "invasive" medical applications, in which the liquid having had contact with the pump is re-introduced to the body.



Micro annular gear pumps exclusively are provided for use in the industrial area. A private use is excluded.



The micro annular gear pumps must not be used in aircrafts and spacecrafts or other vehicles without prior consent of the manufacturer.



The data concerning resistance of the pumps to manipulated liquids is elaborated according to the best of HNP Mikrosysteme's knowledge. However, operating parameters varying from one application case to another, no warranty for this information can be given.



The information given in this manual does not release the customer from personal obligation to check the integrity, correct choice and suitability of the pump for the intended use. The use of the micro annular gear pumps should be conform with technical norms and regulations in force.

If you wish to receive more information than comprised in this manual please contact directly HNP Mikrosysteme.

1.2 Product information

This manual is valid for the micro annular gear pumps mzm-2961 and mzm-4661 manufactured by HNP Mikrosysteme GmbH, Bleicherufer 25, D-19053 Schwerin, Germany.

The bottom line of this manual shows issue and date of issue of the manual.

1.3 Measurements

The pumps are available in two version featuring different liquid connectors. figure 1 shows the version with $\varnothing 2$ mm slip fittings on which flexible tubes with internal diameter < 2 mm are stuck. figure 2 shows the version with a manifold assembly, which is screwed and to a preadapted support.

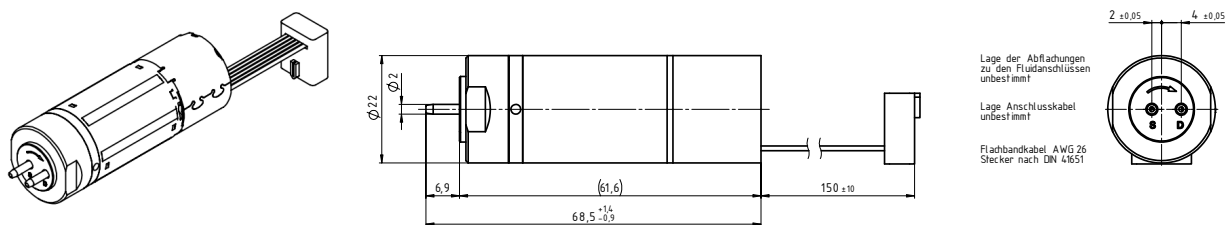

figure 1 Measurement in configuration slip fittings OD 2 mm

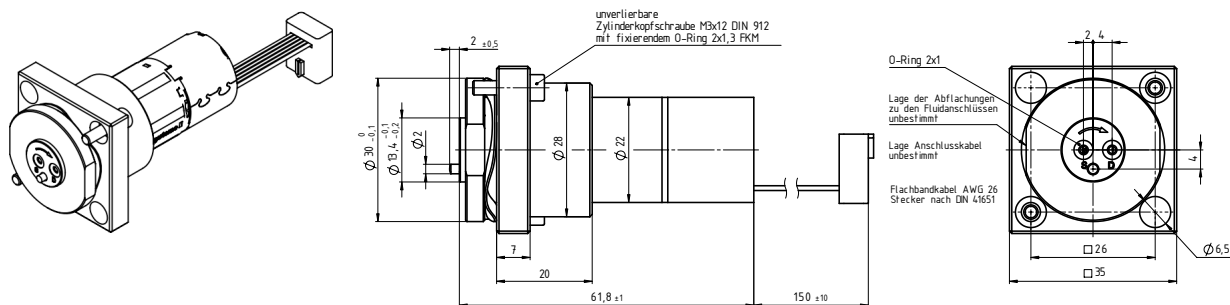

figure 2 Measurement in configuration with manifold assembly M2.1

1.4 Flow chart

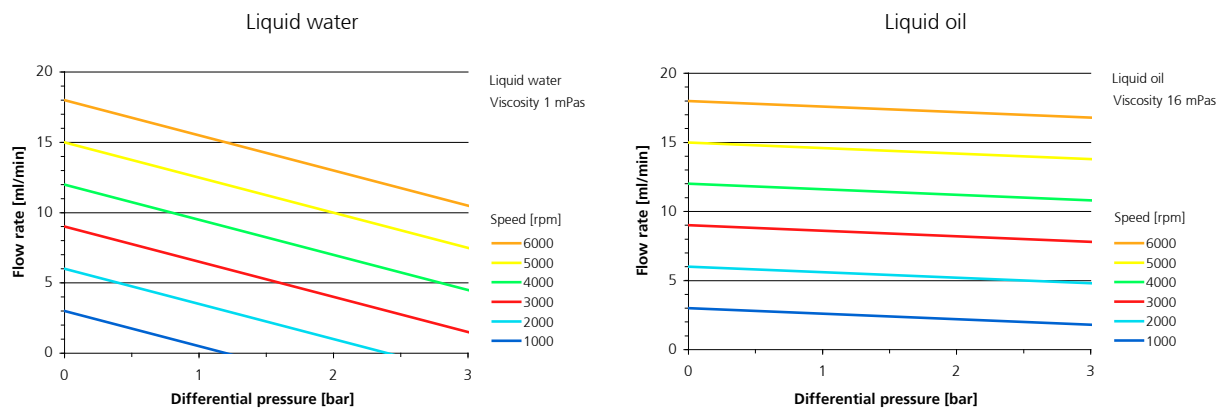

figure 3 Flow charts mzs-2961

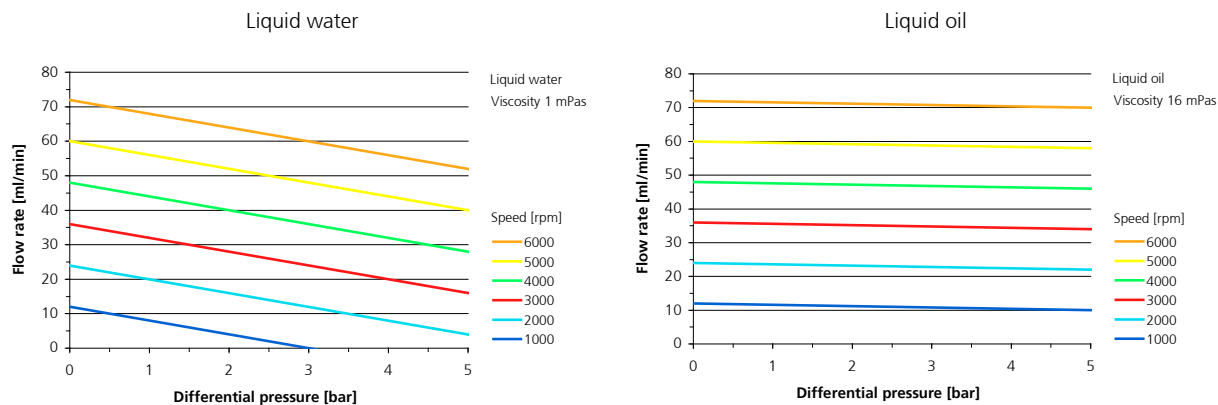

figure 4 Flow charts mzs-4661

1.5 Technical data of the micro annular gear pumps

	mzs-2961	mzs-4661
Technical data		
Displacement volume	3 µl	12 µl
Housing length without fluid connections	62 mm	
Housing length with fluid connections Ø 2 mm	69 mm	
Diameter	22 mm	
Weight	100 g	
Internal volume	85 µl	
Housing material	stainless steel 316L (1.4404), epoxy resin adhesive	
Fluid connector material	stainless steel 316L (1.4404), Titan Grade 5	
Rotor material	tungsten carbide (WC-Ni)	
Shaft material	tungsten carbide (WC-Ni)	
Magnet coating material	gold	
Bearing material	ceramics, Al ₂ O ₃	
Static sealing	FKM optional EPDM, FFKM (Perfluorelastomer)	
Performance parameters		
Min. flow rate Q (at 400 rpm)	1,2 ml/min*	4,8 ml/min*
Max. flow rate Q (at 6000 rpm)	18 ml/min	72 ml/min
Min. dosage volume	5 µl	10 µl
Max. system pressure	6 bar (87 psi) (inlet pressure+differential pressure)	6 bar (87 psi) (inlet pressure+differential pressure)
Differential pressure range	0 – 3 bar (43,5 psi)	0 – 5 bar (72,5 psi)
Viscosity	0.3 – 10 mPas	
Liquid temperature	-15 ... +60 °C	
Ambient temperature	-15 ... +60 °C	
Storage temperature	5 ... 40 °C	
Pulsation of flow (theoretical value)	6 %	
NPSHR value	0.5 m	

*) Values are specified for oil with viscosity 16 mPas. Differing specifications on request

**) Customized solutions on request.

table 1

Technical data of the micro annular gear pump mzs-4661

Warning

The material properties of a liquid (e.g. viscosity, lubricating property, particle content, corrosiveness) impacts the technical data and the lifetime of pumps. Under appropriate conditions the characteristic values may be increased or decreased.

Warning

If you intend to operate the pump out of the range of the above given specification, please consult the manufacturer. Modifications may be necessary to ensure successful operation. Otherwise the pump or the system may be damaged seriously.

1.6 Technical data of the drive

The micro annular gear pumps mzs-2961 and mzs-4661 are provided with a canned motor with integrate speed controller. The motor uses a high dynamic of the micro annular gear pump. With the internal control unit it is possible to manage lower RPM ranges down to 400 RPM. The connection of the motor to a control unit is simple.

Dimensions	
diameter	16 mm
length	43 mm
Data of capacity	
Max. voltage	24 V
Max. permanent torque	5 mNm
output power	8,9 W
No-Load speed by 10 V	2500 rpm
max. permanent current	300 mA
Terminal resistor	12,4 Ω
Rotor inductance	0,440 mH
RPM speed range	400 - 6000 rpm
Temperature range	-15 \div +60 $^{\circ}\text{C}$

table 2 Technical data of the motor

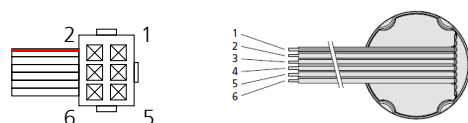

figure 5 Pin configuration of the motor cable

Pin	Description	Value
1	U_p	24 V DC (5 - 28)
2	U_{mot}	24 V DC (6 - 30)
3	GND	
4	U_{nsoll}	0 ... 10 V DC; > 10 V DC - max. U_p , Nominal speed value undefined
5	DIR	to earth or $U < 0.5 \text{ V}$ = anti-clockwise, $U > 3 \text{ V}$ = clockwise
6	FG	max. U_p , I_{max} 15 mA) 6 pulses per revolution

table 3 Pin configuration of the motor



Electrostatic discharges at the connection pin assignment of the ribbon cable can result in irreparable damage to the motor.



While connecting the DC voltage pay attention to the correct polarity, otherwise electronics may be damaged.

2 Safety instructions

Please comply not only with the general safety instructions listed below, but also with specific safety instructions mentioned in the following chapters.

2.1 Safety symbols in this operating manual

Non respect of the safety instructions marked with the following signs represents danger to *people*:

Danger symbol



Safety symbol according to
DIN 4844 – W9

High voltage symbol



Safety symbol according to
DIN 4844 – W8

Non compliance with the safety instructions marked with the following sign represents a risk of damage to the *micro annular gear pump*:

Warning

Operating instructions machined directly on the pump such as the indication of liquid input and output should be followed and kept in a clearly readable condition.

2.2 Staff qualification and training

The staff operating, servicing, inspecting and assembling the pumps must evidence the appropriate qualification for these works. Areas of responsibility and competence as well as monitoring of the staff must be precisely regulated by the operator in charge. If the personnel do not have the necessary knowledge, they must be trained and instructed accordingly. If necessary, this can be implemented by the supplier or the manufacturer on behalf of the operator. Furthermore, the operator in charge must ensure that the content of the present manual has been fully understood by the personnel.

2.3 Safety-conscious work

The safety instructions listed in this operating manual, applicable national regulations concerning accident prevention as well as internal work, operation and safety regulations of the operator must be complied with.

2.4 Safety instructions for the operator

The surface temperature of the motor under full load may exceed 60°C. If needed, this surface should be protected on site against contact in order to avoid skin burns.

The drive should be protected against dust, water vapor condensation, humidity, splash water, aggressive gases and liquids. Please provide for an adequate air ventilation and thus cooling of the motor.

The micro annular gear pump mZR-4661 must not be used in areas exposed to explosion risks or in proximity of inflammable gases and vapors.

Possible leaks of dangerous liquids (for example from the shaft sealing) should be guided away in a way not to represent any danger for the personnel and the environment. The pump should be regularly checked for possible leakage. All legal requirements in this matter should be complied with.

Take care that all risks resulting from the electric energy are excluded. For details please refer to the instructions provided by the authorities in charge or your power supplier.

Warning

Please insure, that the totality of the liquid supply system such as tubes, hoses, filters etc. are free from dust or dirt particles. Impurities such as metal swarf, plastic or glass splinters may impair or damage the pump leading to its failure.

Warning

Please, operate the pump with a filter featuring 10 µm or smaller pores. It will protect the pump.

2.5 Safety instructions for maintenance, check and assembly of the pump

As a rule all maintenance work on the device should be performed when it is at a standstill. The turning-off procedure described in this manual must be followed. Pumps delivering liquids hazardous to health must be decontaminated. Immediately after the work had been completed all safety equipment and protection measures should be applied.

Before starting the operation, please take notice of the instructions listed in the chapter 6.5.

Warning

Should a malfunction of the mZR-pump occur, do not dismantle the pump on your own but contact one of HNP Mikrosysteme service staff for professional assistance.

2.6 Unauthorized pump conversions and spare part manufacture

Conversions or modification to the device are only permitted with prior consent of the manufacturer. Original spare parts and accessories authorized by the manufacturer ensure safety. The use of other parts will annul the liability of the pump manufacturer for any resulting consequences.

2.7 Improper modes of operation

The safety of operation of the delivered device can only be insured by correct use, as described in chapter 1. The limit values given in this manual must not be exceeded in any case.

2.8 General safety instructions

Please observe the following safety instructions



The pump may operate at high pressures. For this reason please use only the delivered accessories and ensure that the employed fittings and tubing have been prescribed and approved for these pressures.



In order to decrease the pressure, provide the system with a *pressure control valve* directing the excess liquid to the storage tank or back to the suction side. In the case of blockage of the pressure side the operating pressure can multiply, this can lead to the damage of downstream components.



At a standstill, the liquid may flow through the pump in the direction of falling pressure. In order to avoid this unwanted movement, please integrate non-return valves (see accessories). This applies also to elevated liquid containers.



Protect the micro annular gear pump and the electric drive against strokes and shocks.



Under normal working conditions the shaft sealing rings integrated in the pump prevent the liquid from leaking out of the device. The micro annual gear pumps are "technically leak-proof" however not "hermetically sealed" which means it may occur that gases or liquids enter to or escape from the pump.



The allowed electrical parameters of the drive must not be exceeded. In particular an incorrect polarity setting of the supply voltage may lead to damage of the control unit.

Warning

Please insure, that the totality of the liquid supply accessories such as tubes, hoses, filters etc. are absolutely free from dust or dirt particles. Impurities such as metal swarf, plastic or glass splinters may impair or damage the pump leading to its failure.

Warning

Please, operate the pump with a filter featuring 10 µm or smaller pores. It will protect the pump.



While connecting the DC voltage pay attention to the correct polarity, otherwise electronics may be damaged.

3 Transport and intermediate storage

3.1 Shipment of the pumps and protection measures

The pumps leaving the factory are secured against corrosion and shocks. The inlets and outlets of the pumps are protected with plastic plugs in order to prevent any foreign bodies from penetrating into the device.

3.2 Transport

In order to avoid any transport-related damage, the package must be protected against shocks. HNP Mikrosysteme guarantees that all goods leave the factory in the best condition. Any noticed damage should be reported to the concerned forwarding agent, authorized dealer or to HNP Mikrosysteme as manufacturer.

3.3 Intermediate storage

Following points concerning pump storage should be observed:

- necessary conservation procedure (see also chapter 7.4.1)
- the protective caps must be put on
- the pump should not be stored in humid places
- for storage temperature - refer to chapter 1.5 of the present manual

4 Description of the pump

4.1 Principle of the Micro annular gear pumps

Micro annular gear pumps are positive displacement pumps. They contain two rotors bearing slightly eccentrically to each other; an externally toothed internal rotor and an annular, internally toothed external rotor (see figure 6). Due to their cycloid indenting, the rotors remain interlocked at any time, forming during rotation a system of several sealed pumping chambers. As the rotors revolve around their offset axis, the pumping chambers increase on the induction (suction) side and simultaneously decrease on the delivery side of the pump (see figure 7). A homogenous flow is generated between the kidney-like inlet and outlet.

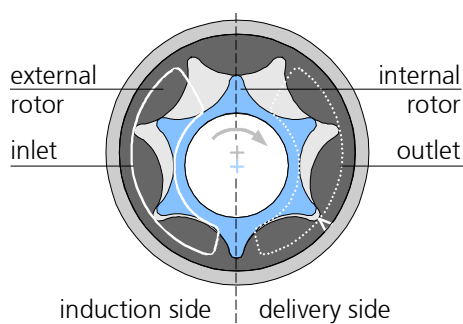

figure 6

Principle of the micro annular gear pump

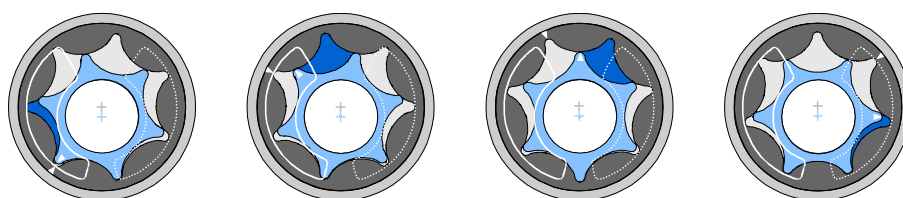

figure 7

Operating principle of the micro annular gear pump

Reciprocating and rotary pumps have a direct allocation to the fed amount of the displacement volume V_g of the pump and its actuator's number of revolutions n . The displacement volume describes the volume, which is theoretically fed with each revolution. The coherence of the flow rate referring to the formula (= volumetric flow rate) Q of the pump is:

$$Q = \eta_{Vol} \cdot V_g \cdot n$$

The volumetric efficiency η_{Vol} describes the coherence of the actual flow rate from the theoretical resulting value. Differences occur according to leaking, as the sealing on the inside of the pump is done over a gap. The volumetric

efficiency is dependent on the media and the pressure against which it has to be fed.

Example: The pump m zr-4661 feeds with its displacement volume of 12 μl with 3000 RPM and a volumetric efficiency of 100 % referring to the above-mentioned formula the flow rate of 36 ml/min. The following table shows the volumetric displacement in dependence to the number of revolutions ($\eta_{Vol} = 100 \%$).

Speed [rpm]	m zr-2961		m zr-4661	
	Q [ml/min]	Q [ml/h]	Q [ml/min]	Q [ml/h]
500	1,5	90	6	360
1000	3	180	12	720
2000	6	360	24	1440
3000	9	540	36	2160
4000	12	720	72	2880
5000	15	900	60	3600
6000	18	1080	72	4320

table 4

Theoretical flow rate of the micro annular gear pumps

The pressure, which the pump has to generate, is given by the construction of the fluidic system and the results of the hydrostatic pressure and the hydraulic resistants (given by tubes, contractions etc.).

The viscosity of the pumping liquid has an important influence on the volumetric efficiency. The volumetric efficiency increases with higher viscosity according to the smaller disengagement through the gaps of the pump.

Cavitation is an effect, which can reduce the volumetric efficiency from in a specific ceiling speed. With increasing viscosity (e.g. > 500 mPas), this ceiling speed is lower. This is the result of the media specified underflow of the steam pressure in the induction port of the pump, in which gases are building up in the pump.

The specific feature of the m zr-pumps is their highly precise design, as well as the guarantee of high accumulator pressure and high accuracy in flow rate and dosage. Therefore, space width and transverse space width of the rotors as well as the interspace to the adjacent case parts lie in the range of just a few micrometers. This precision is at the same time the criteria to achieve a volumetric efficiency in the range of approx. 100 %.

The micro annular gear pump head has an inscription on the front side (see figure 8). The induction connection is marked with the letter »S«, the pressure connection with the letter »D«. An arrow on the front side of the pump indicates the inherent turning direction of the shaft.

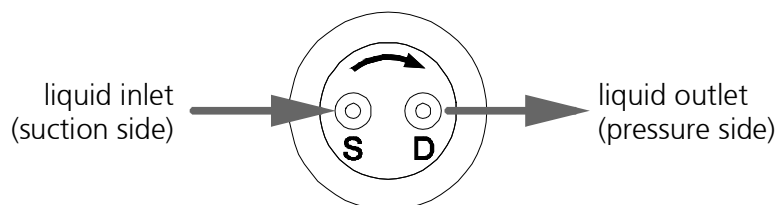

figure 8 Indication of the turning direction and fluidic connections on the front of the micro annular gear pump

4.2 Micro annular gear pump

The micro annular gear pumps mzs-2961 and mzs-4661 is provided with an actuator equipped with a canned motor. The motor works high dynamically and is recommended for dosage operation of the micro annular gear pump. With this control unit it is possible to manage lower RPM ranges down to 400 RPM. For operating, it is recommended to use a power source of 24 V (with a power rating of 2,5 A).

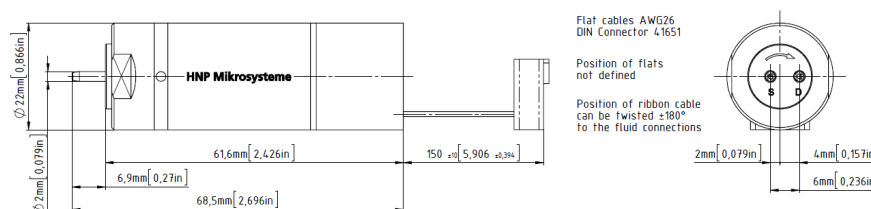

figure 9 Measures of the micro annular gear pump

The mzs-micro annular gear pump consists of the micro annular gear pump head, the coupling unit and an actuator. The pump head is equipped with two fluidic connector bore holes and a shaft for actuation of the rotors. The coupling unit serves as connection between the pump head and the actuator as well as to mount the micro annular gear pump.

The actuators used may be protected against dust, condensing moisture, humidity, splashing, aggressive gases and liquids. Ensure sufficient ventilation and therefore cooling of the motors.

The preferred position to assemble the micro annular gear pump is horizontal. To avoid intruding fluids you may lay the pump under the actuator in vertical operation.

The mechanical assembly of the pump may not be done over the fluidic connectors or the motor.

4.3 Materials and liquids

The components of the micro annular gear pump heads are manufactured of tungsten carbide (with 10% nickel binder) and nickel bronze.

The liquid resistance is to be checked in single cases. Feeding of non-lubricant liquid reduces the service life of the micro annular gear pumps.

4.4 Liquid supply

We are able to supply the micro annular gear pump head in two kinds.

Slip fittings

The micro annular gear pump head is equipped with two front slip fittings with OD 2 mm for connection of flexible tubes with the ID < 2 mm (such as 1/8" hose).

The suction side is indicated with the letter »S« the delivery side with the letter »D«. An arrow in the front of the pump indicates the operating direction of the shaft.

In order to prevent foreign bodies from penetrating into the pump, the liquid inlet and outlet are protected by plastic caps. Please remove them before you assemble the pump.

Manifold assembly M2.1

The micro annular gear pump with manifold assembly has been designed for integration into systems. The benefit of the manifold assembly is diminished cubage for easier integration of the micro annular gear pump and higher pressure resistance.

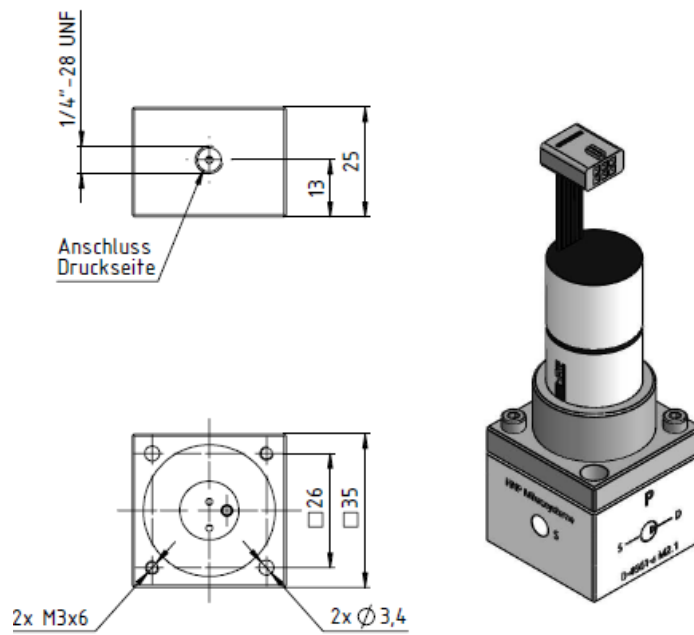

figure 10 Drawing manifold assembly M2.1 (figure with mzs-4661)

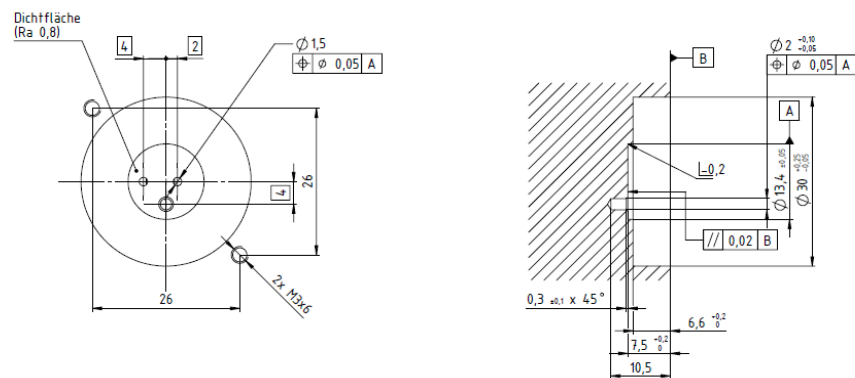

figure 11 Dimensions configuration version

5 Optional modules

The spectrum of applications of the magnetic hermetic micro annular gear pump series may be expanded by using different additional modules. The modules allow for special dosage tasks, which could otherwise not be accomplished with a standard pump version. The modules may be combined with each other and with almost all available pump heads and motor versions.

- By-pass module for the delivery of minimal constant flow rates down to the nanoliter range (see chapter 5.1)

Due to specific requirements of each application the configuration of a given pump version should be discussed with the technical service. Additional customized modules may be designed on demand.

5.1 By-pass module (optional)

The by-pass module allows constant minimal volume dosage with flow rates in the nanoliter range. The technology is based on the division of flow generated by the micro annular gear pump, according to the relationship of fluidic resistance of two predefined capillaries. The micro annular gear pump generates a master circulation from which a side dosage current is derived. This micro flow capillary allows to obtain flow rates starting at 1 $\mu\text{l/h}$. The minimal and the maximal flow rate may differ by a factor of 1000 (dynamic factor). In order to determine the lower flow rate limit, both capillaries need to be carefully configured. It is possible to obtain flow rates between 1 and 10,000 $\mu\text{l/h}$.

The by-pass module assures dosage of minimal amounts of liquids at a very high constancy of flow and a pressure-resistant flow rate.



figure 12

The by-pass module example with mzs-2521

Performance parameters	
Operating flow rate range	1 – 10,000 $\mu\text{l/h}$
Differential pressure range	0 – 3 bar
Max. applied inlet pressure	1 bar
Pulsation	<1 %
Operating temperature	-20 ... +60 °C
Viscosity range	0.5 – 100 mPas
Fluid connections	– Liquid intake: tube or hose, OD 1/8" – Master capillary: tube, OD 1/8" (return line to the tank) – Side current capillary: tube, OD 1/16" (dosage capillary)
Wetted parts	stainless steel 316L, PEEK
Measurements	□ approx. 32 x 25 mm (by-pass module without pump)
Weight	approx. 140 g (by-pass module without pump)

table 5

Technical data of the by-pass module

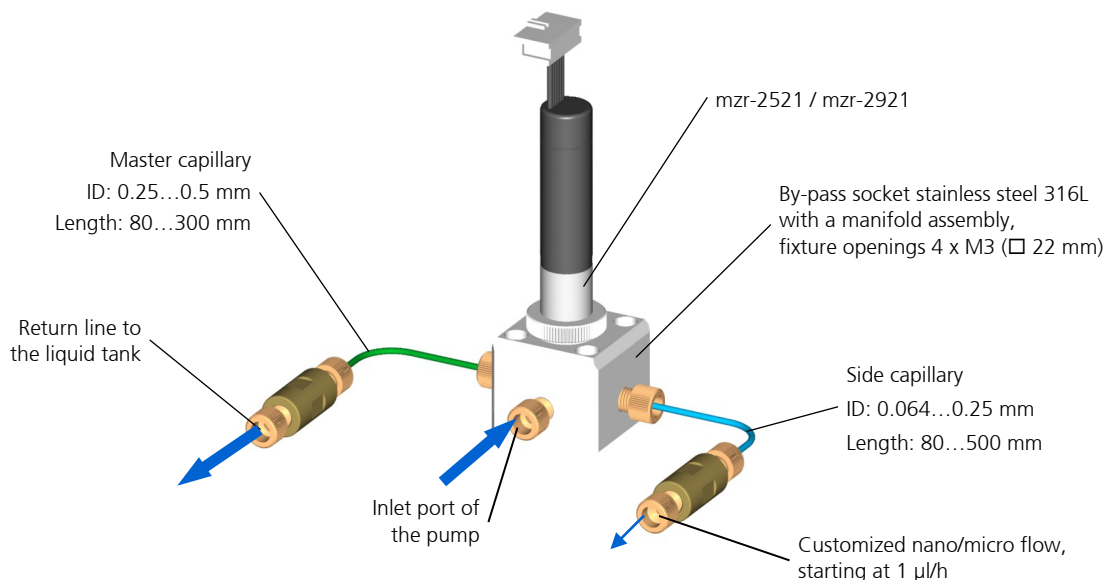

figure 13 Construction of a by-pass module with mzs-2521

Working principle

The by-pass module shown in the figure 13 divides the flow generated by the micro annular gear pump into master and side circulation. The module serves at the same time as a support and fixture for the micro annular gear pump. The selection and configuration of the different components of the system is calculated by a PC. The master circulation capillary (the tube going back to the liquid tank) and the pump are selected and configured for each customer-specific dosage task. In this way the pump operates with the desired volumetric efficiency and can generate pressures reaching beyond the required pressure level. Depending on the difference of pressures between the delivery side of the pump and the system, a side current capillary is designed and precisely adjusted so that the desired minimal flow rate is obtained at its outlet. The flow charts of the by-pass module are verified before the shipment.

Flow chart examples

Flow rate range 100 – 9000 µl/h

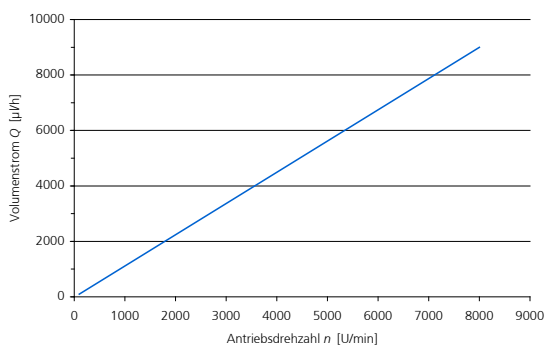

Flow rate range 0.6 – 4.4 µl/h

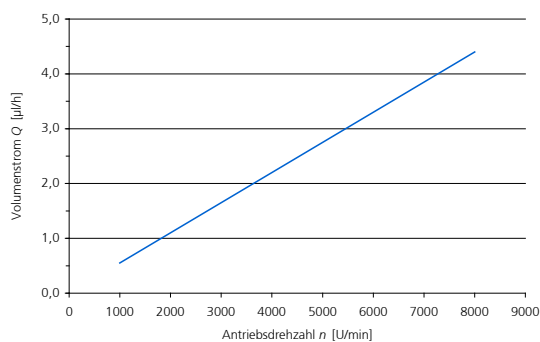

6 System integration

6.1 Checkup before the first assembly

Inspect the pumps for potential damage during the shipment (see chapter 3.2).

Please check according to the following points if the right pump type has been delivered:

- Compatibility with the delivered liquid
- Viscosity range
- Pump performance (displacement volume, dosage volumes, operating pressures)
- Operating temperature range



If you notice any difference between the required and the delivered pump type, please contact HNP Mikrosysteme. Do not put the pump into operation without prior approval.

6.2 Mounting of the micro annular gear pump

The fixing of the micro annular gear pump can be vertical or horizontal. To prevent possible entry of liquid, mounted the level of the motor be above the level of the pump head.

Warning

Install the pump in such a way that in case of failure no liquid can enter to the motor or controller.



If the pump is mounted flexibly or dosing tasks require change of pump position, please fasten the cable with an adapted cable tie at the motor in order to avoid strain. If the pump is moved over a longer time, the cable may break at its connection to the motor.



Take precautions that in case of leakage no surrounding objects or environment will be exposed to danger.



The motor must be protected against humidity, dust or sweat.

6.3 General instructions for the assembly of the liquid supply network

Foreign bodies and dirt particles can block the micro annular gear pump and lead to its damage.

Warning

Please note that all the components of the liquid supply system should be clean and flush them if needed before pump installation. Remember to remove all remaining splinters or swarf from connection fittings, rests from liquid containers and any dirt from valves, tubing and filters.

Warning

Operate the pump with a filter featuring 10 µm or smaller pores. The filter protects the pump from particles and dirt.



If the pump is connected once again with a hose that has already been used, the enlarged ending of the hose should be cut off in order to prevent it from slipping off and the liquid from flowing out of the connection.

Assembly of the tubing and piping system

1. Please cut the tubing rectangular with a hose cutter. If metal pipes are used an intensive cleaning procedure is necessary. After machining the pipes have to be cleaned and flushed very carefully. Smallest swarfs within the fluidic system can cause failure of the micro annular gear pump.
2. Connect the fittings with the tubing respectively the pipe work according to the attached installation instruction.



Please note that the correct assembly of tubes respectively pipes with the pump head is a necessary condition to secure the right direction of flow. When you want to operate the pump in reverse direction please contact HNP Mikrosysteme since this is not possible in any application.

3. The suction line should be installed ascending to the pump for better degassing. The suction line should be designed as short as possible. The inner diameter of the suction line should be large to guarantee good priming of the liquid. At the planning of the pipe system take care of possibilities for degassing.
4. Operate the micro annular gear pump always with a filter with a pore size of 10 µm or smaller. The filter prevents that particles or solids penetrate into the pump what can cause major damage.
5. Avoid dry running of the pump. Make sure that the liquid flow is not interrupted.

6.4 Filter selection and use

In majority of cases it is recommended to integrate a filter on the suction side of the micro annular gear pump to ensure its secure operation. The recommended filter pore or mesh size should not exceed 10 µm. The penetration of particles or swarf that could cause a blockage or damage to the pump can only be avoided by using an adapted filter.

HNP Mikrosysteme offers a choice of standard filters covering a broad spectrum of applications. You may count on our assistance for the selection of the most suitable filter.

In order to select the best adapted filter, such operating parameters as the flow rate, the viscosity and the degree of pollution of the liquid will be needed. An increase in at least one of the mentioned terms will require the use of a bigger filtering element or pressurization of the delivered liquid. In case no suitable filter for the given high-viscosity liquid can be found, it is possible to use a filter with slightly larger pore size. Prior discussion with HNP Mikrosysteme is here recommended. A filter with larger pores is still better than no filter at all. As an alternative solution an already filtered liquid may be used.

Warning

Because filters have a large internal volume, it is recommended to fill in the filter and the induction (suction) tubing with already filtered liquid in order to avoid a too long dry run of the pump during the first operation.

Warning

Please control regularly the filtering elements for pollution. Cleanse regularly the filter or replace it with a new one. A polluted filter may considerably decrease the volumetric efficiency of a pump. Furthermore, because of the cavitation effects dosage imprecision and even pump damage may occur.

Warning

A too small filter (too little filtering surface) may considerably decrease the volumetric efficiency of the micro annular gear pump. What is more, because of the cavitation effects dosage imprecision and even pump damage may occur.

6.5 Operation with terminal box S-G61

The micro annular gear pump is connected via the Terminal Box S-G61. This enables an easy startup of the pump due to:

- the possibility to connect the voltage supply with the delivered screw clamp terminal
- speed set via potentiometer
- analog voltage input 0-10 V for speed controller
- Change the speed setting via jumpers
- Direction input
- Frequency output (FG), on status LED to indicate the operating status (normal / fault) or optional output error on existing screw
- Internal reverse polarity protection

In order to operate the pump a supplementary source of 24 VDC will be required. The ampacity of the voltage source should amount to around 2 A for the micro annular pumps mzz-2961 and mzz-4661.

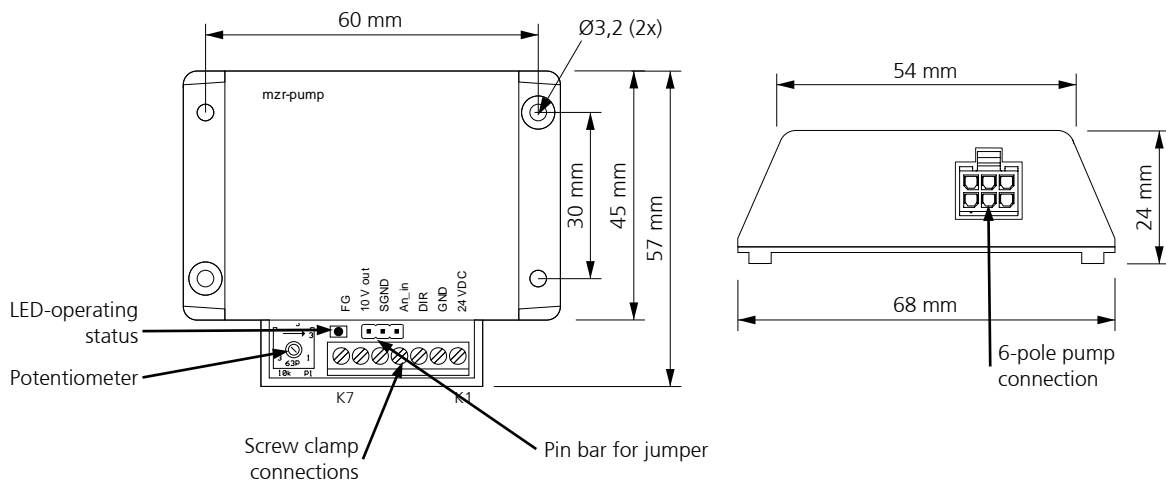

figure 14

Measurements of the Terminal Box S-G61

Technical data

General technical data			
Terminalbox		S-G61	
Power supply electronic	U	24 (5 ... 28 V)	V DC
Power supply electronic coil	U _B	24 (6 ... 28 V)	V DC
Max. continuous output current	I _{dauer}	1,5 *	A
Max. peak output current	I _{max}	1	A
Total standby current	I _{el}	0,02	A
Speed range		1000 ... 6000 *	rpm
Output voltage for external use	10 V out	10 max. 200 mA	V
Nominal input speed	An_in	10-Bit AD-converter	
	Voltage range	0 ... 10	V
	Potentiometer	10 kΩ (Pegel 0 ... 10 V)	
Sense of rotation (input)	DIR	low 0 ... 0,5 or GND ⇒ counterclockwise high 3 ... U _B or open ⇒ clockwise	V
	Input resistance	R _{in} ≥ 10 kΩ	
Digital output	FG	Output frequency max. 50 mA, high 16 ... U _B :	
	Number of pulses	6 lines per revolution	
Weight with housing		35	g

* Values limited in the control unit with corresponding software

table 6

General technical data

Nr.	Configuration	Nr.	Configuration
K1	24 VDC	1	U _P
K2	GND	2	U _{Mot}
K3	DIR	3	GND
K4	An_in	4	U _{nsoll}
K5	SGND	5	DIR
K6	10 V out	6	FG
K7	FG		

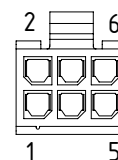

table 7

Configuration of the screw connections

Configuration of the 6-pole motor connector



	Poti
	0 ... 10 V

table 8

Jumper configuration for the analog speed input

Startup of the micro annular gear pump

Voltage supply

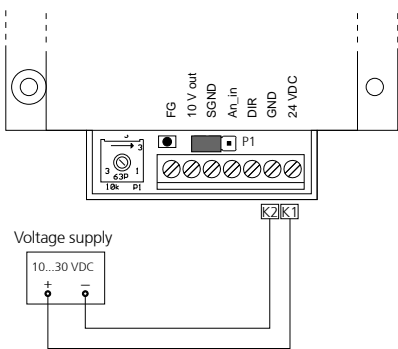

Pay attention to the correct polarity of the voltage supply, otherwise electronics will be damaged.

The length of voltage supply cable should not exceed 10 m, or the control unit could be damaged by inductance overvoltage.

Analog nominal signal

Potentiometer internal operating mode

connected with jumper pins P3 and P2

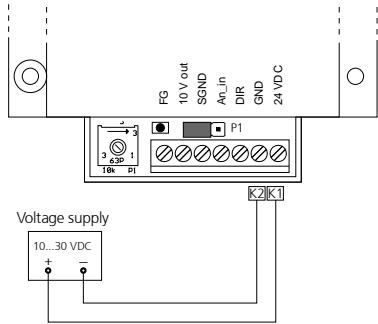

Potentiometer external operating mode

connected with the jumper pins P2 and P1

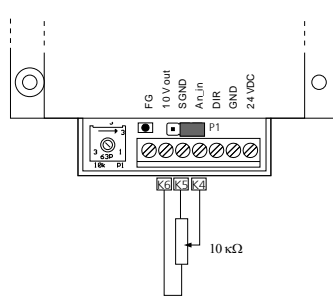

0 ... 10 V operating mode

connected with the jumper pins P2 and P1

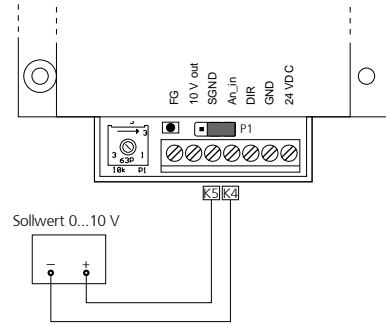

Digital inputs

Sense of rotation input

- High-Pegel (3 V... U_B) or open: pump turn clockwise (to the right)
- Low-Pegel (0 ... 0,5 V) oder GND: Pump turn counterclockwise (to the left)

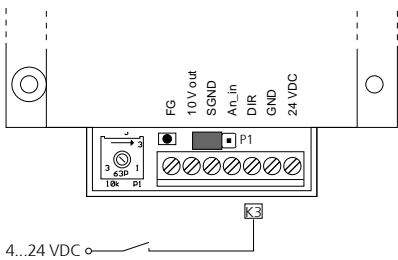

Digital output

Speed signal output

Digital output: 6 lines per revolution

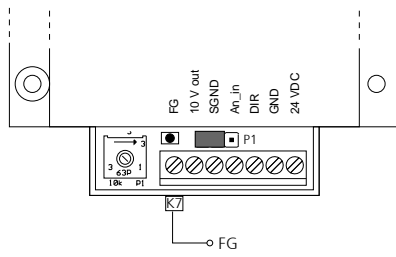

7 Start Up / Shut Down

7.1 Preparing for operation

After the liquid supply system had been completed, please check once again the operating conditions of the micro annular gear pump as according to the following points:

- Are the inlet and outlet tubes or hoses correctly connected?
- Is the entire liquid supply system clean - that means free of particles, foreign bodies, pollution or swarf?
- Has a filter been installed on the suction side?
- Has a sufficient amount of the right liquid been supplied?
- The pump does not run the risk of a longer dry operation?
- The entire liquid supply system has been checked for leakage?
- Is it possible to stop the pump by an emergency switch if an unexpected malfunction occurs at the first start?

7.2 Startup of the micro annular gear pump

- Switch on the voltage supply. The micro annular gear pump can now be put into operation by turning the potentiometer knob, by sending a nominal external voltage signal.
- Start the filling in of the pump at low or middle speed (1000 - 3000 rpm).

Warning

Avoid dry operation of the pump over a longer time. The pump should be filled in before it is put into operation.

7.3 Flushing procedure after use

After each service the micro annular gear pump should be carefully flushed with a non-corrosive, filtered and particle-free flushing liquid (see table 9 / table 10). During the flushing procedure the pump should operate at about 3000 rpm and if possible against a low pressure (that can be obtained by using a restrictor, a capillary or similar). The flushing liquid must be compatible with the delivered liquid and be suitable for solving the remaining liquid rests. Depending on the application for example water, or isopropanol may be used. If you have doubts whether a liquid is suitable for this function or not, please ask the manufacturer of the liquid or HNP Mikrosysteme.

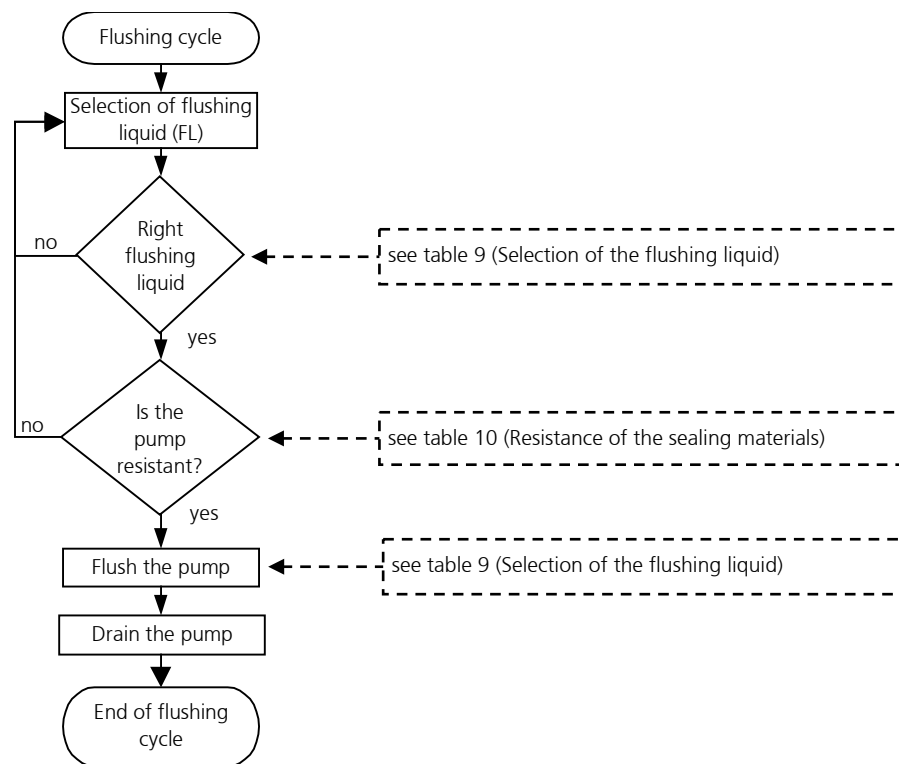

figure 15

Flushing procedure

Warning

Liquids remaining in the pump may crystallize, coagulate or lead to corrosion and as a consequence impair the work of the micro annular gear pump.

Warning

Please make sure that the pump components and particularly O-rings and sealing are resistant to the employed flushing liquid (see table 10).

Warning

The flushing liquid (solvent) and the recommended duration of the flushing procedure depend on the delivered liquid (see table 9). The indicated flushing liquids are simple recommendations and should therefore be checked by the user as to their compatibility and suitability.



Regulations concerning the use of substances dangerous to health should be followed!

	Nature of the handled liquid	Flushing cycle [min]	Suitable flushing liquid
1	Oils, fats, plastifiers	15-20	isopropanol, ethanol, acetone, benzine
2	Solvents (polar + nonpolar)	5-10	isopropanol, ethanol
3	Other organic liquids	10-15	isopropanol, ethanol
4	Refrigerating and cooling agents	15-20	isopropanol, ethanol
5	Neutral watery solutions	20-25	isopropanol, ethanol
6	Basic solutions	25-30	DI-water (deionized water)
7	Organic acids	30-40	isopropanol, ethanol
8	Weak mineral acids	25-30	DI- water
9	Strong mineral acids	35-45	DI- water
10	Strong oxidizing liquids	35-45	DI- water
11	Paints, varnishes, adhesives	50-60	Not specified - for further information please contact HNP Mikrosysteme.

table 9 Selection of the flushing liquid (solvent) and the duration of the flushing cycle depending on the delivered liquid.

Warning

Please make sure that the pump components and particularly O-rings and sealing are resistant to the employed flushing liquid (see table 10).

Flushing liquid	Shaft sealing		O-ring material		
	PTFE (Teflon®), graphite- reinforced	UHMWPE	FPM (Viton®)	EPDM	FFPM
acetone	0	0	3	0	0
benzene	0	3	1	3	0
benzyl alcohol	0	-	0	2	0
benzine	0	0	0	3	0
butanol	0	-	1	0	0
dimethyl sulfoxide (DMSO)	0	0	3	0	0
ethanol	0	0	0	0	0
isopropanol	0	0	0	0	0
methanol	0	0	2	0	0
methylethylketone (MEK)	0	0	3	1	0
oil / fine mechanics oil	0	0	0	3	0
styrene	0	-	1	3	1
toluene	0	1	2	3	0
water	0	0	0	0	0
xylene	0	1	2	3	0

Legend: 0 ... good suitability 1 ... suitability 2 ... conditional suitability 3 ... labile - ... not specified

table 10 Resistance of the sealing materials depending on the flushing liquid (solvent)

7.4 Shutdown of the micro annular gear pump

During the shutdown of the pump the following steps should be followed

- Flush the pump with a filtered and particle-free flushing liquid (solvent) (see chapter 7.3)
- After the flushing procedure decrease speed of the pump to 0 rpm
- Fill the pump with a suitable conservation liquid (see chapter 7.4.1)
- Remove the pump from the system (see chapter 7.4.2)

By proceeding as shown in the diagram (see figure 16) you may prepare the pump for a longer standstill.

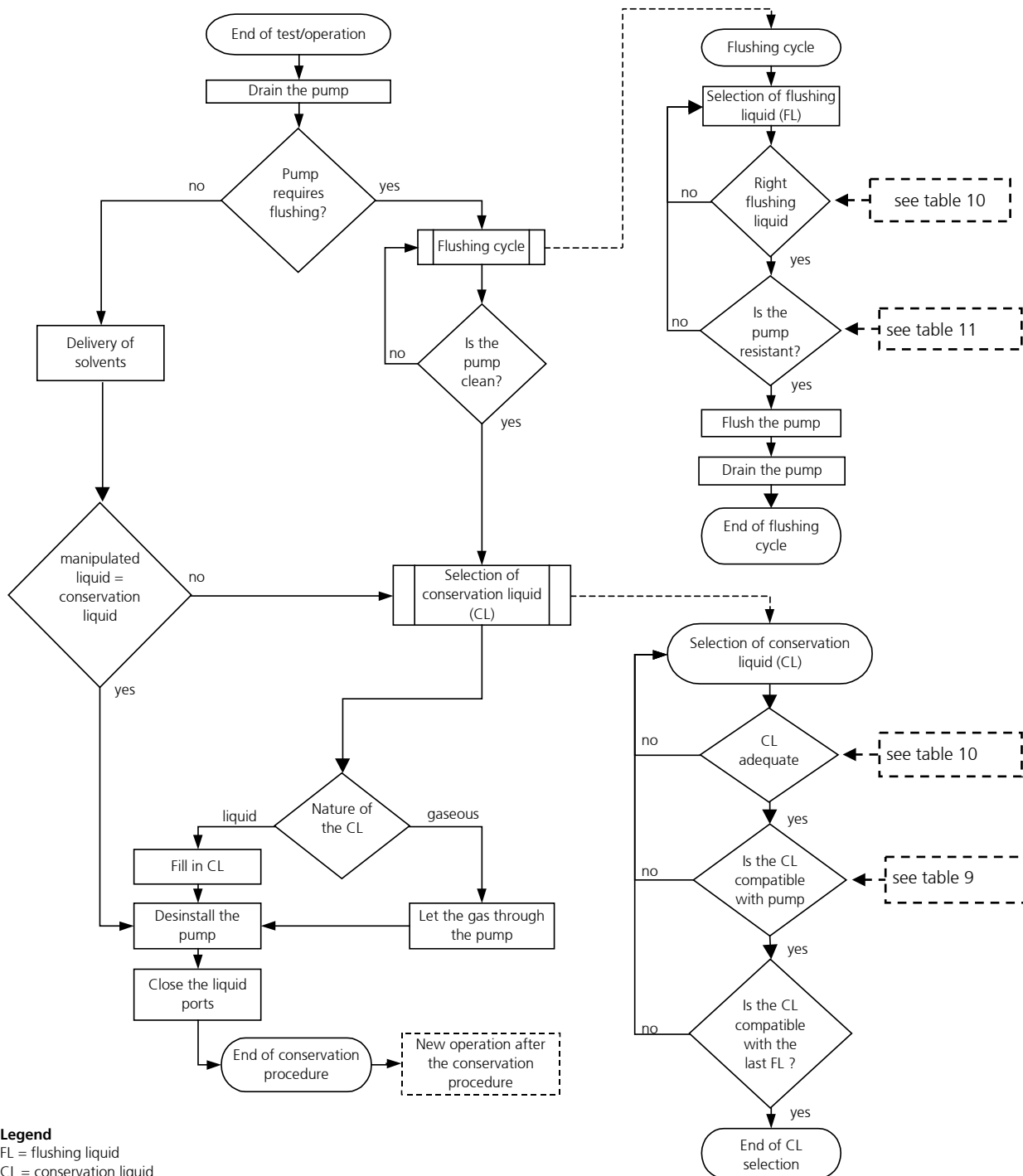

figure 16 Shutdown procedure

7.4.1 Conservation

If the micro annular gear pump operates at irregular intervals or for other reasons should be put out of operation for a longer period, it should, after service and flushing procedure (see chapter 7.3), be filled in with a suitable conservation liquid.

The conservation liquid may be selected from the table 11 depending on the duration of the standstill and the resistance of the pump to the manipulated liquid (table 10). The indicated conservation liquids are simple recommendations and should therefore be checked by the user as to their compatibility and suitability. The figure 17 presents the diagram of conservation liquid selection.

Remark: This diagram is repeated as a part of the figure 16 »Shutdown procedure«.

After the cleansing procedure the pump should be filled with a suitable conservation agent. You will find a choice of possible conservation liquids in the table 11.

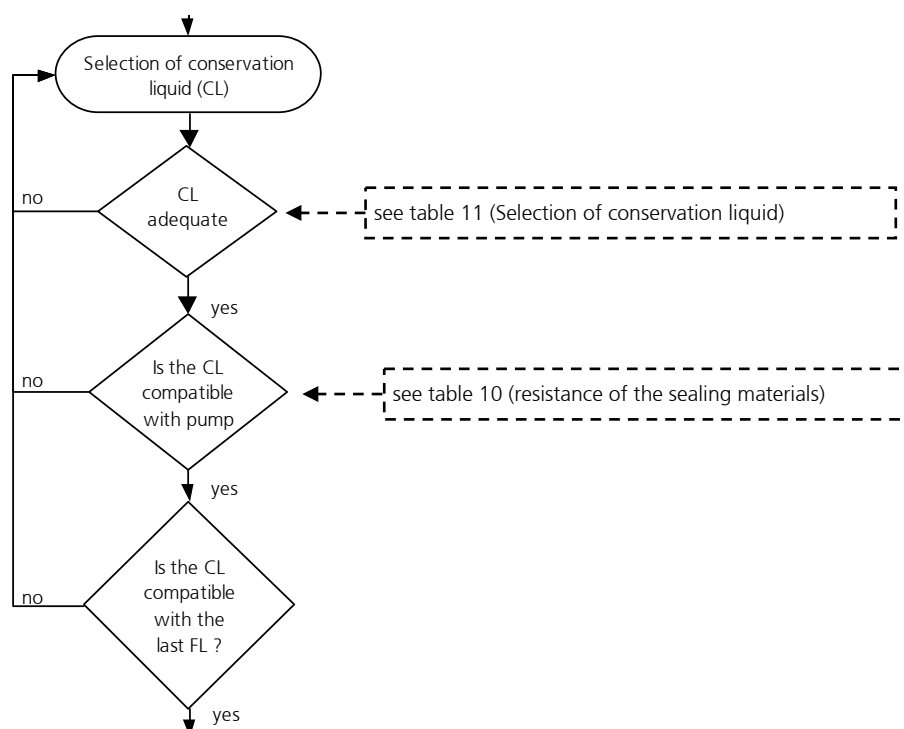

figure 17

Selection of the conservation liquid (CL)

Liquids	Solubility in water	Compatibility with the delivered liquid	Duration of storage	Breakaway torque	Toxicology	Viscosity	Description
isopropanol	+	+	o	o	o	+	solvent for organic compounds, cosmetics, essential oils, waxes and esters, antifreezers, antiseptic agents
acetone	+	+	o	o	o	+	solvent for a number of organic compounds, unlimited solubility in water, dissolves natural and synthetic resins, fats, oils and commonly used plastifiers
ethanol	+	+	o	o	o	+	solvent for organic compounds, fats, oils and resins
DI-water	+	+	-	-	+	+	solvent for many organic and mineral liquids
fine mechanics oil	-	-	+	+	+	+	cleansing and protective action (dissolves fats, tar, rubber or adhesive substances, protects against corrosion)
hydraulic oil	-	-	+	+	+	-	lubricating and preserving properties (<i>Warning</i> : may resinatate or deteriorate with time)
nitrogen	-	+	+	+	o	+	is not a solvent, may leave deposits after drying out
air / compressed air		+	+	+	+	+	is not a solvent, may leave deposits after drying out

Legend: + ... good/suitable o ... satisfactory; - ... bad/inadequate

table 11 Selection of the conservation liquid

In order to prevent dust particles and foreign bodies from penetrating into the pump or the conservation liquid from leaking out, please secure the liquid input and output with the delivered protective plugs or screws.

Warning

Water or deionized water (DI-water) *should not* be used as conservation agents. These liquids germinate already after a few days and build a biofilm which can later block the pump.

7.4.2 Dismantling of the system

- Put the drive out of operation by turning down speed to 0 rpm and by switching off the voltage supply. Make sure that the procedure described in the chapter 7.3 has been completed.
- Now that the pump has been stopped you may remove it from the system.
- Protect the inlet and outlet openings of the pump with adapted protective caps or screws.

7.5 Trouble shooting

If the pump does not start to operate or stops the operation abruptly, please proceed as follows:

Try to liberate the micro annular gear pump:

- by turning the potentiometer knob back and forth or by sending an analog voltage signal
- via the control software
- by pressing with a syringe a suitable flushing liquid (see table 9 and table 10) through the micro annular gear pump
- by changing the operating direction of the pump.

If these measures turn out to be ineffective, please contact the service staff of HNP Mikrosysteme (see chapter 11) and send the pump back to the manufacturer for inspection.

Warning

You should under no condition try to dismantle the pump by yourself. This may cause damage to the pump components and consequently annul your warranty claims.

7.6 Return of the micro annular gear pump to the manufacturer

For the return of a micro annular gear pump and components that have already been employed, please follow the instructions:

- drain any remaining rests of the delivered liquid from the pump
- flush the pump with an adapted solvent
- remove the filter elements from integrated or loosely delivered filters
- protect all openings against dust with the delivered protective plugs or screws
- return the pump in its original packing

The service personnel which carries out the repair should be informed about the condition of the used micro annular gear pump. This is done by means of the "Declaration of media in contact with the micro annular gear pump and components" (see chapter 17). This form may also be downloaded from the web site www.hnp-mikrosysteme.de/download.



The "Declaration of media in contact with the micro annular gear pump and components" must imperatively be filled in. The nature of liquid which entered into contact with the micro annular gear pump and the components must be specified.

In case of non-compliance, the sender will be liable for any resulting injury to persons or any object damage.

8 Accessories for microfluidic systems

The accessory range for the liquid delivery systems of HNP Mikrosysteme comprises complementary equipment such as supplementary modules, hoses, tubing, fluid connection fittings, filters and non-return valves that are best adapted to your micro annular gear pump. We will eagerly share our long date experience as far as component selection is concerned.

9 Non-liability clause

HNP Mikrosysteme GmbH shall not be liable for damages resulting from the non-respect of instructions comprised in this operating manual.

It remains at the responsibility of the user to conform to all laws, rules and regulations in force. This applies above all to the handling of aggressive, poisonous, corrosive and other dangerous liquids as well as to the electromagnetic compatibility (EMC).

10 Problems and their removal

Disturbance	Cause	Solution
1 The pump does not start operation.	No power supply	Check the power supply.
2 The pump does not deliver any liquid.	No liquid in the primary tank.	Fill the recipient/tank with liquid.
	Presence of air or gas in the pump	The pump cannot run dry against the system pressure. Fill in the pump at no pressure or at reduced system pressure.
	Malfunction of the liquid supply system (such as in the delivery tube or hose, the needle or external non-return valve)	Check the components for possible disturbances to be eliminated. Cleanse the accessories if needed.
	Failure of the electric installation.	Check the electric installation for the correct cable configuration, loose contacts, etc.
	The pump did not receive the start signal or start conditions are not fulfilled.	Check if the start conditions have been fulfilled start signals (PLC, start input) and the programming. Read the operating manual for the motor control unit.
3 The pump does not start to operate.	The pump does not take in the liquid.	The tubing on the suction side is too long or has a too small internal diameter (a too low NPSHA value).
		The tubing or the fluid connection on the suction side are not tight. Please check the intake connection and the tubing.
		Air bubbles in the system (tubes, valves, ...)
		If the viscosity of the liquid is too high, apply pressure on the suction side.
		Check the pressure exerted on the primary liquid tank.
		An external non-return valve does not open. Check the non-return valves. Submit the non-return valve to a higher pressure, so that the pump may fill in.
4 The motor turns, but the pump does not operate.	No liquid in the pump	Fill the pump with liquid.
	Air bubbles in the liquid supply system (tubing, valves, ...)	Fill the pump and the liquid supply system with liquid.
	The non-return valve does not open.	Rinse the non-return valve.
	Blocked delivery tubing or needle	Cleanse, flush or exchange the delivery tubing or dosage needle.
	The coupling between the motor and the pump is out of position.	Return the pump to the manufacturer.
	The pump shaft is broken.	Return the pump to the manufacturer.
5 The pump is filled with liquid, but does not pump it.	Presence of particles in the delivered liquid or blockage of the pump	Adapt the motor current of the control. Contact the manufacturer of the pump.
		Check the motor error status with the Motion Manager software. Try to liberate the pump by making it operate in a reverse direction for 1 s with - 1000 rpm.
		Flush the pump with a syringe.
		Return the pump to the manufacturer for cleansing. Use a filter, flush the liquid delivery system.
		The non-return valve does not open.
Blockage of the delivery tubing or the	Cleanse, flush or exchange the delivery	

Disturbance	Cause	Solution
	needle	tubing or the needle.
	Air bubbles in the liquid delivery system (tubing, valves)	Fill in the pump and the liquid delivery system with liquid.
6 Dosage volume does not correspond to the desired values.	Air bubbles in the liquid delivery system (tubing, valves ,...) and the pump	Vent the liquid delivery system and check for untight fluid connections.
	Pump shows cavitation.	Too long or too narrow intake tubing. Shorten the intake tubing or change the position of the pump.
	Polluted or too small filter	Change the filter to a new or bigger one.
	The non-return valve does not open.	Rinse the non-return valve.
7 Speed of the pump cannot be adjusted.	Defective electric installation	Check the electric installation for correct cable configuration and loose contacts.
	Defective drive control	Return the drive control unit to the manufacturer.
	Encoder cable disconnected	The motor works at high speed. Check the installation, return the pump to the manufacturer for checkup.
8 Liquid drops from the dosing needle.	The non-return valve does not close.	Rinse the non-return valve.
	Too high pressure on the primary liquid tank	Stop the delivery of compressed air on the primary liquid tank.
	The liquid tank is at a higher level than the dosing needle.	Place the liquid tank at the same or slightly lower level as the pump.
9 Liquid leaks out of the sealing module.	Too high pressure on the sealing liquid supply cartridge or defective sealing	Stop pressurizing the sealing liquid supply cartridge. If needed return the pump to the manufacturer.
10 Dosage volume decreases with time.	Polluted filter	Exchange the filter.
	Deposits in the pump	Flush the pump or return it to the manufacturer for dismantling and cleaning.
	The pump is worn after a long operating period or after use with abrasive liquids.	New definition of the calibration factor of the pump, by modifying the pump characteristics graph necessary.
11 Leakage from the pump	The sealing does not function correctly.	Return the pump to the manufacturer.
12 Leakage from the coupling assembly	Defective shaft seal	Return the pump to the manufacturer in order to change the shaft sealing.
13 Leakage from the fluid connections	Untight locking rings	Exchange or tighten the fluid connections, exchange the fluid connection.
14 Air bubbles on the delivery side.	Loose fluid connections (particularly on the induction (suction) side)	Check and tighten the fluid connections.
	The shaft seal is untight or worn.	Return the pump to the manufacturer.
15 The error status of the pump cannot be retrieved.	No connection with the pump	Check the supplied voltage.
		Check the connection of the interface with the null-modem cable. Replace the cable if needed.
	The motor control unit does not respond.	Turn off the voltage supply for a short time, then turn it on again. Start the pump automatically with the integrated control unit.
16 Minimal leakage during standstill	No error, cause relative to the operating principle	Use a non-return valve. Place the liquid tank at the same or slightly lower level as the pump.
17 Excess temperature	The surface of the pump is hot.	Clean the surface of the pump, rinse the pump.
	The pump operates with difficulty.	The pump should be flushed.
	Particles in the delivered liquid or deposits in the pump	The operation of the pump should immediately be stopped! Return the pump to

Disturbance	Cause	Solution
		the manufacturer for cleansing.
	Noise of beveling	The operation of the pump should immediately be stopped! Return the pump to the manufacturer for cleansing and repair.
	The motor surface or the motor interior are too hot.	High temperature indicator in the drive is on. The motor has been shut down by the thermistor. Return the pump to the manufacturer.
18 The pump is noisy.	Wear out of the pump or defective components.	Do not continue to operate the pump, return it to the manufacturer for maintenance.
19 Overcurrent	Particles in the delivered liquid	Rinse the pump.
	The pump operates with difficulty.	Dosing needle is damaged. Needle should be cleansed, flushed or exchanged. Tubing on the delivery side, dosing needle or the non-return valve is blocked. Cleanse, flush or exchange the components.
	Deposits inside the pump.	Flush the pump. If necessary return the pump to the manufacturer.
20 Undervoltage	Voltage supply < 12 VDC	Check the power supply 24 VDC
21 Overvoltage	Voltage supply > 28 VDC	Check the power supply 24 VDC. The drive control unit may be damaged. Return the pump to the manufacturer.

table 12

Problem shooting



If a disturbance that has not been mentioned in the above list, or that makes the use of the micro annular gear pump unsafe appears, please stop the operation of the pump without delay and contact HNP Mikrosysteme (see chapter 11). If needed return the pump to the manufacturer for checkup.

11 EC Directive

A Directive or EC Directive is a legal instrument of the European Community addressing at the member states and forcing them to implement specific regulations or targets. Leastwise, micro annular gear pumps are covered, by the scope of application of the following Directives: The following directives are of importance for the user of the described micro annular gear pumps:

Low-Voltage Directive (2014/35/EU)

The Low-Voltage Directive is not relevant for micro annular gear pumps described in this manual, because the supply voltage is limited to a maximum of 30 VDC.

Machinery Directive (2006/42/EU)

A micro annular gear pump is a machine and is consequently covered by this Directive. However, it may be a part of a machine or installation.

EMC Directive (2014/30/EU)

The Directive on Electromagnetic Compatibility (EMC) applies to all electronic and electrical devices, installations and systems. Consequently, the Motion Controller of the micro annular gear pump is covered by the EMC Directive.

RoHS Directive (2011/65/EU)

To our knowledge our products delivered to you do not contain substances or applications in concentrations that are forbidden by this directive. No substances contain our products delivered to you after our current knowledge in concentrations or application, the placing on the market in products according to the valid requirements forbade to the Directive.

WEEE Directive (2002/96/EU)



Disposal of micro annular gear pumps has to be environmentally sound. All materials and liquids have to be recycled in accordance with the relevant regulations. Electrical parts can not be disposed of as household waste. They have to be delivered to designated collection points.

REACH regulation (EC) No. 1907/2006

HNP Mikrosysteme is not a manufacturer or importer of chemical substances subjected to registration, but in terms of regulation, a downstream user. As downstream user, we conduct the necessary communication with our suppliers to ensure future deliveries of all components necessary to us. We will notify you of all relevant, changes in our products, their availability and the quality of parts/products delivered by us within our business and coordinate the appropriate action in individual cases with you. Previous inspection did not show any limitation in the supply of material from our upstream suppliers.

11.1 Electromagnetic Compatibility (EMC)

Electromagnetic compatibility is defined as the ability of a electric or electronic device to function satisfactorily as intended in its electromagnetic environment without introducing intolerable electromagnetic disturbances in that environment.

11.1.1 EMC Directive and Standards

Comformity was proven by proof of compliance with the following harmonized standards by the company Dr. Fritz Faulhaber:

- EN 61000-6-4 (10/01): Generic standards – Emission standard for industrial environments
- EN 61000-6-2 (10/01): Generic standards – Immunity for industrial environments

These standards prescribe certain standardised tests for the emitted-interference and interference-immunity tests. The following tests are required due to the connections on the controller:

Generic Standard on Emitted Interference:	Description
EN 55011 (05/98)+A1(08/99)+A2(09/02):	Radio disturbance characteristics
Generic Standard on Interference Immunity	
EN 61000-4-2 (05/95)+A1(4/98)+A2(02/01):	Electrostatic discharge immunity test
EN 61000-4-3 (04/02)+A1(10/02):	Radiated, radio-frequency, electromagnetic field immunity test
EN 61000-4-4 (09/04):	Electrical fast transient/burst immunity test
EN 61000-4-5 (03/95)+A1(02/01)	Surge immunity test
EN 61000-4-6 (07/96)+A1(02/01):	Immunity to conducted disturbances, induced by radio-frequency fields
EN 61000-4-8 (09/93)+A1(02/01):	Power frequency magnetic field immunity test

Table 1

Standards Summary

All tests were conducted successfully.

11.1.2 Information on use as intended

For micro annular gear pumps, note the following:
Requirement for the intended operation is the operation according to the technical data and the manual.

Restrictions

If the micro annular gear pumps are used at home, in business or in commerce or in small businesses, appropriate measures must be taken to ensure that emitted interferences are below the permitted limit values!

12 Declarations of conformity

The delivered micro annular gear pump falls within scope of the following EC directives:

- Machinery Directive (2006/42/EU)
- EMC Directive (2014/30/EU)

You may request the declarations of conformity for the micro annular gear pumps from us separately.

EC-manufacturer's certificate (following Machinery Directive 2006/42/EU)

We hereby declare that the following micro annular gear pump of the magnetic hermetic series:

mzr-2961, mzr-4661

are intended for installation into another machinery/plant and that start of operation is forbidden until it is identified that the machinery/plant into which these micro annular gear pumps shall be installed corresponds to the regulations of the EC guidelines regarding safety and health requirements.

We confirm the conformity of the product described above to the following standards in terms of applied directives

- Machinery Directive (2006/42/EU)

Applied standards are particularly

DIN EN 809	DIN EN 60204-1	DIN EN 294
DIN EN ISO 12100 part 1		DIN EN 953
DIN EN ISO 12100 part 2		UVV

This statement does not warrant any characteristics in terms of product liability. Please note the safety instructions in the manual.

Mr. Lutz Nowotka, HNP Mikrosysteme GmbH, Bleicherufer 25, D-19053 Schwerin is authorised to compile the technical file according to Annex VII A.

Date: 17 May 2013

Signature manufacturer:

Dr. Thomas Weisener
CEO

EC-manufacturer's certificate (following EMC Directive 2014/30/EU)

We hereby declare that the following micro annular gear pump of the magnetic hermetic series:

mzr-2961, mzr-4661

are intended for installation into another machinery/plant and that start of operation is forbidden till it is identified that the machinery/plant into which these micro annular gear pumps shall be installed corresponds to the regulations of the EC guidelines regarding safety and health requirements.

We confirm the conformity of the product described above to the following standards in terms of applied directives

– EMC Directive (2014/30/EU)

Applied standards are particularly

EN 61000-6-4 (10/01): Generic standards – Emission standard for industrial environments

EN 61000-6-2 (10/01): Generic standards – Immunity for industrial environments

This statement does not warrant any characteristics in terms of product liability. Please note the safety instructions in the manual.

Date: 19 April 2016

Signature manufacturer:

Dr. Thomas Weisener
CEO

13 Service, maintenance and warranty

Maintenance of the micro annular gear pump should be carried out depending on the delivered liquid:

- *for lubricating liquids* after 6000 working hours, but not later than 15 months after the initial operation
- *for non-lubricating liquids, crystallizing liquids or liquids containing particles*, after 4000 working hours but not later than 12 months after the initial operation. If during the first inspection no substantial wearout of the pump is observed, the following inspection under the same working conditions should be performed after 6000 working hours, yet not later than 15 months following to the last inspection.

If during the first inspection the pump shows a particularly strong wearout, the maintenance intervals should be readapted to the changing operating parameters.

In order to prevent a strong wearout of the pump, the pump should be shut down properly after every application as described in the chapter 7.3. A supplementary flushing procedure with a neutral flushing liquid (see chapter 7.3) also slows down the wearout process of the pump.



It is not allowed to open or dismantle the micro annular gear pumps. The warranty extinguishes with the expiry of the legal warranty period or with the opening of the pump. Furthermore HNP Mikrosysteme cannot give any warranty of exchange for parts whose damage result from incorrect use.



For service and maintenance please return your micro annular gear pump to HNP Mikrosysteme. You will find the address on the cover of the present operating manual.



The declaration of media (liquids) having had contact with the micro annular gear pump and components must imperatively be completed. The nature of media (liquids) must be specified. In case of non-compliance the sender will be liable for any resulting injury to persons or any object damage.



Sealing elements, rotors and shaft are parts that undergo wear and will be replaced by HNP Mikrosysteme GmbH during maintenance depending on their degree of wear.

14 Contact person

Development and application assistance, service and accessories

Mr. Sven Reimann
Phone +49| (0) 385|52190-349

Service and maintenance

Mr. Steffen Edler
Phone +49| (0) 385|52190-307

Drive and control technology

Mr. Lutz Nowotka
Phone +49| (0) 385|52190-346

15 Legal information

Marks

mzr® is a registered German trademark of HNP Mikrosysteme GmbH.

MoDoS® is a registered German trademark of HNP Mikrosysteme GmbH.

µ-Clamp® is a registered German trademark of HNP Mikrosysteme GmbH.

HNPM® is a registered German trademark of HNP Mikrosysteme GmbH.

Teflon® is a registered trademark of DuPont.

Viton® is a registered trademark of DuPont Dow Elastomers.

Kalrez® Spectrum™ is a registered trademark of DuPont.

PEEK™ is a registered trademark of Victrex plc.

HASTELLOY® is a registered trademark of Haynes International, Inc.

Aflas® is a registered trademark of ASAHI Glass Ltd.

Microsoft®, Windows® are registered trademarks of Microsoft Corporation in the USA and in the other countries.

Cavro® is a registered trademark of Tecan Systems, Inc.

Other product names or descriptions not mentioned above are possibly registered trademarks of related companies.

Patents

Micro annular gear pumps (and housings) are protected by assigned patents: EP 1115979 B1, US 6,520,757 B1, EP 852674 B1, US 6,179,596 B1, EP 1354135, US 7,698,818 B2. Patents pending DE 10 2011 001 041.6, PCT/IB2011/055108, EP 11 81 3388.3, US 13/884,088, CN 2011 8006 5051.7, HK 13 11 2934.9, DE 10 2011 051 486.4, PCT/EP2012/061514, EP 12 728264.8, US 9,404,492 B2, CN 2012 8003 8326.2. In the US, Europe and China additional patents are pending.

16 Safety information for the return of already employed micro annular gear pumps and components

16.1 General information

The operator carries the responsibility for health and safety of his/her employees. The responsibility extends also to employees not belonging to the company that have a direct contact with the micro annular gear pump and its components during repair or maintenance works. The nature of media (liquids) coming into contact with the micro annular gear pump and its components must be specified in the corresponding declaration form.

16.2 Declaration of media in contact with the micro annular gear pump

The staff performing the repair or maintenance works must be informed about the condition of the micro annular gear pump before starting any work on the device. The "Declaration of media in contact with the micro annular gear pump" should be filled in for this purpose.

The declaration should be sent directly to the supplier or to the company designated by the supplier. A second copy of the declaration must be attached to the shipment documents.

16.3 Shipment

The following instructions should be observed for the shipment of the micro annular gear pump.

- drain the pump from any remaining liquid
- flush the pump with an adapted flushing liquid
- remove the filter elements from the integrated or loosely delivered filters
- all the openings should be air-tight plugged
- return the pump in the original packing

17 Declaration of media in contact with the micro annular gear pump and its components

Type of the device

Pump type/serial number/article no.: _____
Operating hours/running time: _____
Number of delivery note or delivery date: _____
Reason of return: _____

Contact with media (liquids)

The micro annular gear pump was in contact with:

and has been rinsed with:

Product info sheet / Material Safety Data Sheet: yes* no

* Please attach file

or is available on the following web site: www. _____

If a pump which had contact with dangerous substances could not be properly cleansed prior to shipment, we reserve the right to entrust a specialized company with cleansing of the device. The return of the pump in original packing is advisable. It is necessary in order to protect the employees and delivery staff.

Nature of media contact:

explosive oxidizing sensitive to moisture
 toxic (toxic byproducts) radioactive pH-value: approx. _____ to _____
 carcinogenic microbiological other: _____
 irritant corrosive _____

R-statements: _____ S-statements: _____

Declaration

Hereby I/we affirm that the stated information is complete and correct. Micro annular gear pump and accessories are shipped in conformity with the applicable regulations.

company: _____ Mrs Mr title: _____
division: _____ name: _____
street, no.: _____ phone: _____
ZIP/city: _____ e-mail: _____
country: _____

city, date: _____ authorized signature /
company stamp:

18 Appendix

– Layouts

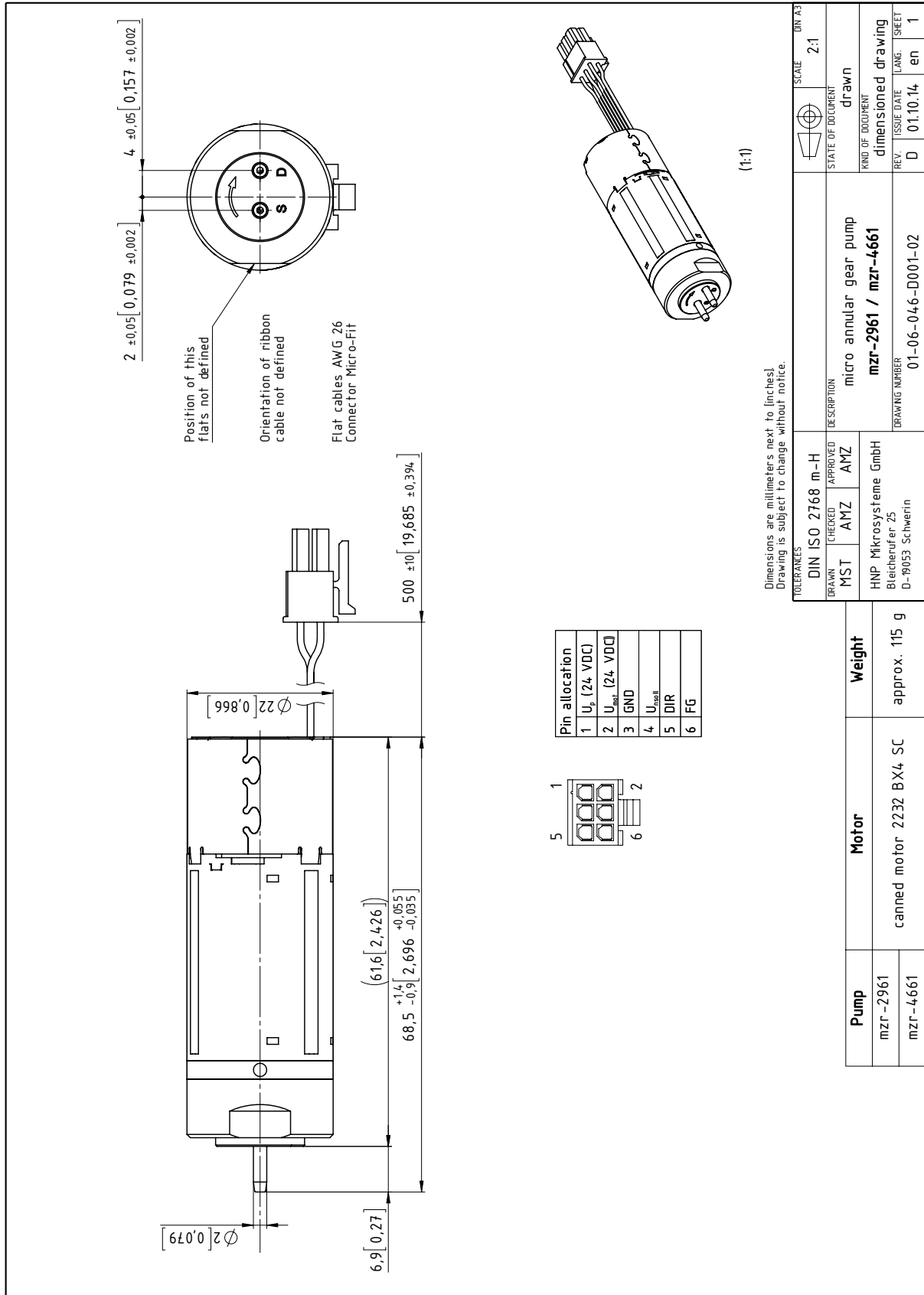

figure 18 Data sheet of the micro annular gear pump mzt-4661

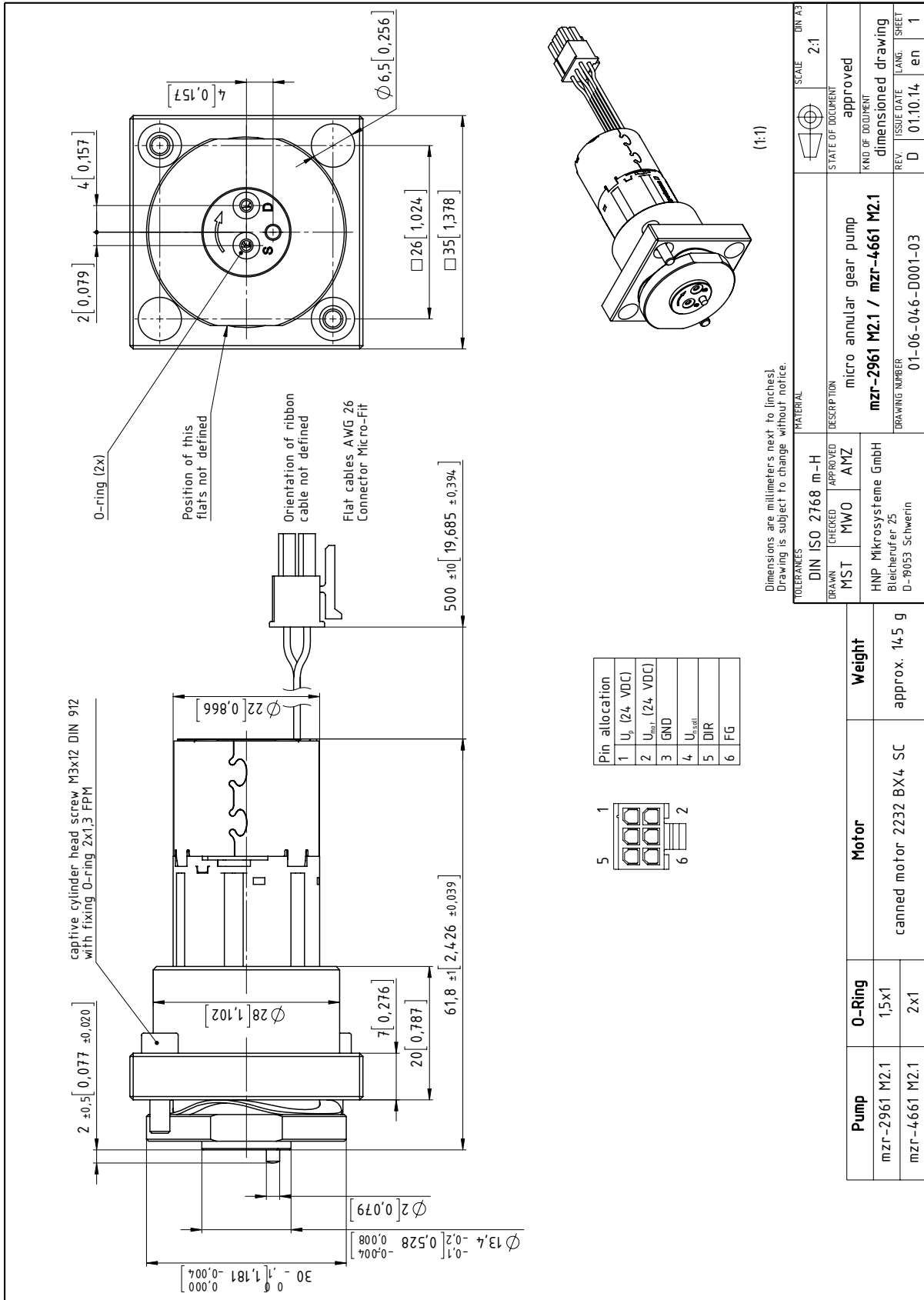

figure 19

Data sheet of the micro annular gear pump mZR-4661 configuration with manifold assembly M2.1