

Product information

mzr-11543 · Modular pump series

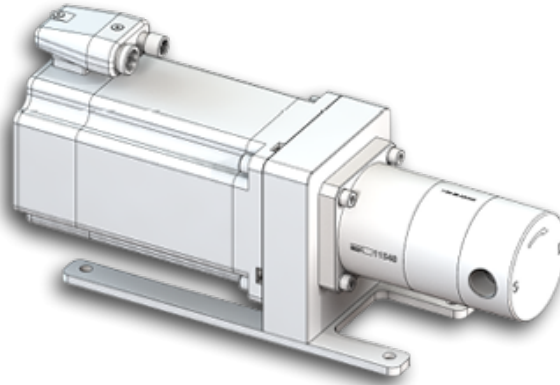

Description

Micro annular gear pump mzr-11540 of the modular pump series operates with high dynamics, low pulsation and excellent precision in delivery as well as high repeatability in metering. The pump is suitable for low to high viscosity liquids and a differential pressure of up to 15 bar. It allows accurate displacement volumes starting at 100 µl in a metering time of 200 milliseconds. It also covers a flow rate range of 0.2 to 1152 ml/min. The pump comes with lateral fluid connections or with a manifold version with frontal fluid connections.

Advantages

- High precision in metering and delivery
- Dynamic drive technology in regards to requirements with BLCD drive, BLCD drive with electronic module, stepper motor
- Broad viscosity range solvents, adhesives, water, grease, gel, colors
- Long service life wear-resistant tungsten carbide
- Low pulsation delivery, low shear stress rotary micro annular gear technology, no valves

Applications

- Mechanical engineering
- Chemical and pharmaceutical industry
- Process engineering
- Adhesives and sealants applications
- Spray-coating technology
- Coating technology
- Metering of different additives
- Filling technology
- Dosing of inks and colors

Technical data

Drive version	stepper motor
Flow rate	0.192 – 96ml/min
Smallest dosage volume	100µl
Displacement volume	192µl
Differential pressure range	0 - 15 bar (217.5 psi)
Maximum inlet pressure	15 bar (217.5 psi)
Liquid temperature range	-5 ... +60 °C (+23 ... +140 °F)
Ambient temperature range	0 ... +40 (+32 ... +104 °F)°C
Viscosity range	0.3 – 10,000mPas
Precision CV	1% (Coefficient of variation CV)
Fluid connection	3/8" NPT, lateral
Wetted parts	stainless steel 316 L, tungsten carbide Ni-based; shaft sealing: graphite-reinforced PTFE, Alloy C276; static sealing: FKM, optional: EPDM, FFKM
Motor	stepper motor; NEMA 34-Standard; bipolar, 9.5 A, step angle 1.8° (full step), IP 65
Velocity range	1 - 500rpm
Positioning	number of steps
Motor protection	protection against overload
Interface	plug M16, M12
Cable length	1.8m
Dimensions (L x W x H)	287 x 86 x 132 mm
Weight	approx. 8.2 kg
Remarks	* Customized solutions on request.

Notice

Even if single parameters are within the indicated performance range of technical data, certain parameter combinations may not be achievable. Single parameters may exceed their indicated performance range under adequate circumstances. For detailed evaluation please contact HNP Mikrosysteme. Actual performance may vary. Specifications are subject to change without notice.

Accessories

- Reservoir Plastic
- Heat insulation module

Dimensions

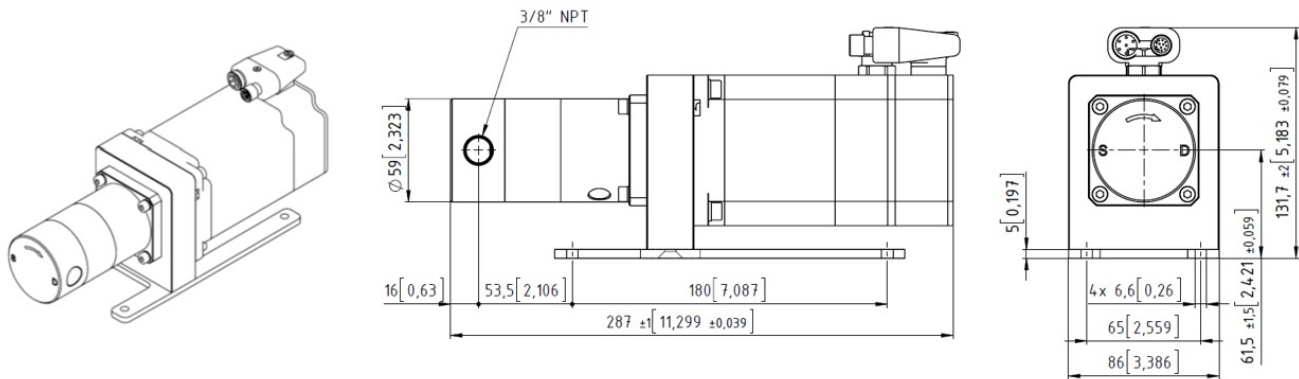

Flow charts

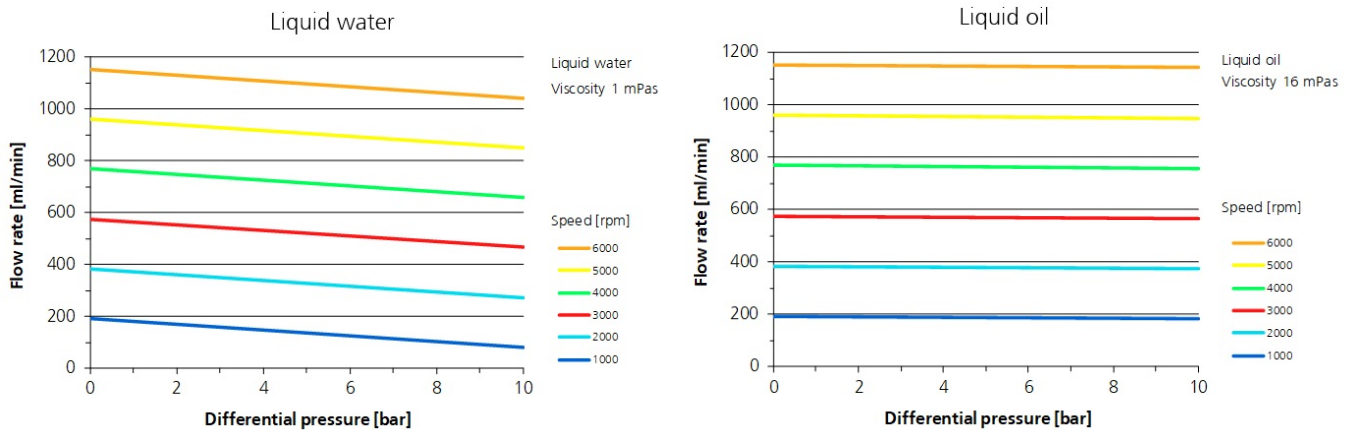

Patents and trademarks

Micro annular gear pumps (and housings) are protected by assigned patents: EP 1 354 135 B1; US 7,698,818 B2; DE 10 2011 001 041 B4; CN 103 348 141 B; US 10,012,220 B2; CN 103 732 921 B; US 9,404,492 B2; US 6,520,757 B1.
 HNPM[®], mZr[®], MoDoS[®], µ-Clamp[®], µDispense[®], Centifluidic Technologies[®], LiquiDoS[®], smartDoS[®], ColorDoS[®] are registered German trademarks of HNP Mikrosysteme GmbH.

Contact

HNP Mikrosysteme GmbH
 Bleicherufer 25
 19053 Schwerin
 Germany

T +49 385 52190-300
 F +49 385 52190-333
 info@hnp-mikrosysteme.de

Last update 2019/08