

Product information

mzr-2909X2 Ex · Ex-versions



Description

The micro annular gear pump mzr-2909X2 Ex cover the flow range 0.003 - 12 ml/min. The highly precise, low pulsation small volume dosage even of non-lubricating liquids or at high pressure, the compact design of the Ex-pumps, the broad viscosity range and the small dimensions are unique features of this pump series. The pumps are applied in the field of chemical and process technology and are suitable for both continuous delivery and discrete dosage of watery solutions, solvents, oil and other viscous liquids. Accessories extending the operating parameters of the device are available.

Advantages

- Ex-certification ATEX conform with EU Directive 2014/34/EU
- Precision motor and sophisticated control ATEX DC-servomotor with integrated microcontroller
- High dosage precision precision CV < 1 % at low volumes
- Compact dimensions length < 356 mm, including Ex-motor
- Broad viscosity range methanol, solvents, adhesives, grease, gel
- Low pulsation delivery, low shear stress rotary micro annular gear technology

Dimensions

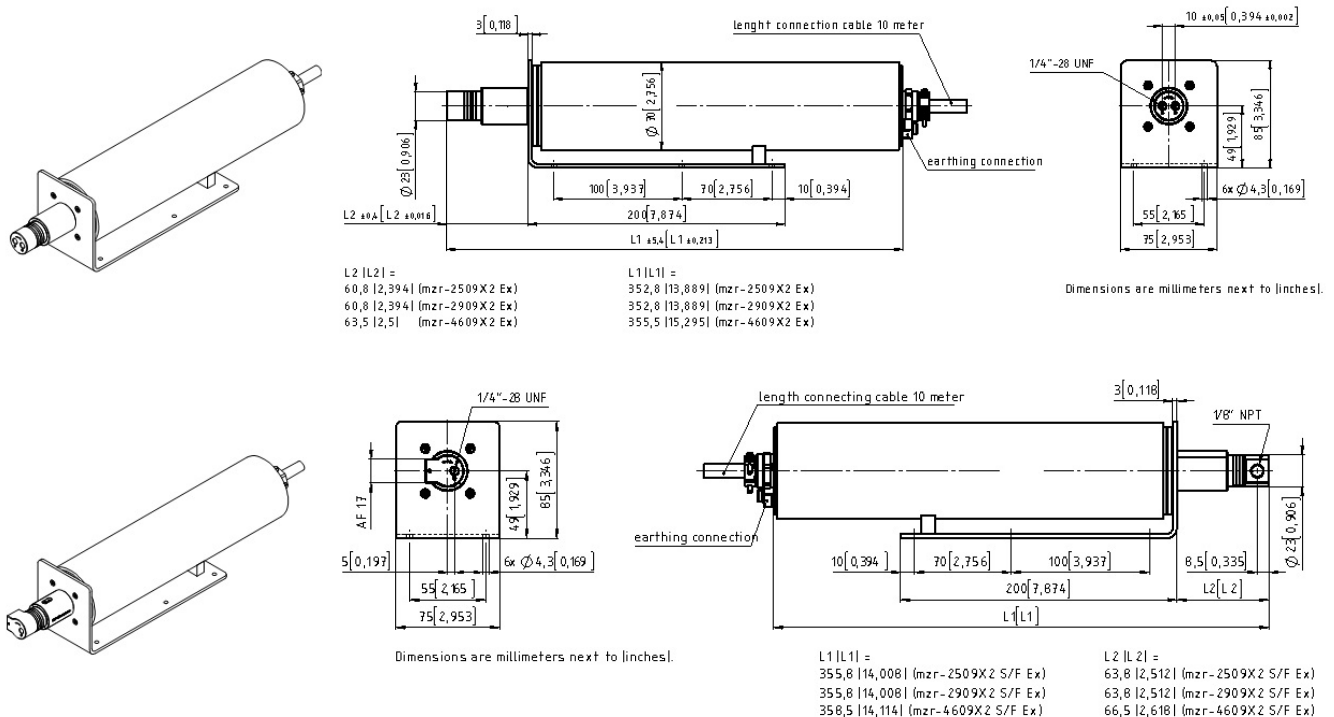

Technical data

Flow rate	0.003 - 12 ml/min
Smallest dosage volume	0.5µl
Displacement volume	3µl
Differential pressure range	0 – 5 bar (73 psi)
Maximum inlet pressure	5 bar (73 psi), (10 bar (145 psi) *)
Ambient temperature range	0 ... +40 (+32 ... +104 °F)°C
Liquid temperature range	-5 ... +40 °C (+23 ... +104 °F)
Viscosity range	0.3 - 5,000 mPas
Precision CV	< 1% (Coefficient of variation CV)
Ex-certification	CE Ex II 2G c IIC T5 X
Place of installation	Ex-area zone 1, 2
Wetted parts	stainless steel 316L (1.4404, 1.4435), Ni-based tungsten carbide; shaft seal: graphite-reinforced PTFE, 316L; static seals: FPM, optional: EPDM, FFFPM
Motor	BLDC motor with integrated motion controller, 24 V DC, 2 A, 53 W, analog hall sensors (3000 pulses / revolution)
Velocity range	1 - 4,000 rpm
Cable length	10m
Weight	approx. 3,200 g
Remarks	* with optional fluidic seal module, Customized solutions on request.

Notice

Even if single parameters are within the indicated performance range of technical data, certain parameter combinations may not be achievable. Single parameters may exceed their indicated

performance range under adequate circumstances. For detailed evaluation please contact HNP Mikrosysteme. Actual performance may vary. Specifications are subject to change without notice.

Accessories

- Terminal box S-G05
- Reservoir Plastic
- m zr-Touch Control

Patents and trademarks

Micro annular gear pumps (and housings) are protected by assigned patents: EP 1 354 135 B1; US 7,698,818 B2; DE 10 2011 001 041 B4; CN 103 348 141 B; US 10,012,220 B2; CN 103 732 921 B; US 9,404,492 B2; US 6,520,757 B1.

HNP M[®], m zr[®], MoDoS[®], μ -Clamp[®], μ Dispense[®], Centrifluidic Technologies[®], LiquiDoS[®], smartDoS[®], ColorDoS[®] are registered German trademarks of HNP Mikrosysteme GmbH.

Contact

HNP Mikrosysteme GmbH
Bleicherufer 25
19053 Schwerin
Germany

T +49 385 52190-300
F +49 385 52190-333
info@hnp-mikrosysteme.de

Last update 2019/08