

Product information

mzr-2505 · High performance pump series



Description

The micro annular gear pump mzr-2505 covers the flow rate range 0.0015 - 9 ml/min. To the main assets of the device belong high precision, low pulsation, low volume dosage even of non-lubricating liquids or at high pressures, compact design and an integrated microcontroller. The pump allows dosage in a broad viscosity range and shows small, economic dimensions. The mzr-2505 targets applications in industrial production and process technology. The pump has been designed for continuous delivery and discrete dosage of water, watery solutions, solvents, methanol, oil, lubricants, adhesives, inks and paints as well as other high viscosity liquids.

Advantages

- High dosage precision
precision CV < 1 % at low volumes
- High differential pressures
achievable also for low viscosity liquids
- Compact dimensions
length 140 mm, including controller
- Broad viscosity range
methanol, water, solvents, adhesives, grease, gel
- Low pulsation delivery, low shear stress
rotary micro annular gear technology
- Long service life
wear-resistant tungsten carbide
- Precision motor and sophisticated control
DC-servomotor with integrated microcontroller

Applications

- Chemical processing
- Industrial and plant engineering
- Packaging
- Medical and pharmaceutical industry
- Mini plant technology
- Spray technology
- Dispensing of adhesives
- Ink and paint dosage
- Vacuum applications

Technical data

Flow rate	0.0015 - 9 ml/min (min. 10 µl/h *)
Smallest dosage volume	0.25 µl
Displacement volume	1.5 µl
Differential pressure range	0 – 30 bar (435 psi)
Maximum inlet pressure	5 bar (73 psi)
Liquid temperature range	-5 ... +60 °C (-20 ... +150 °C *) +23 ... +140 °F (-4 ... +302 °F *)
Viscosity range	0.3 - 25,000 mPas
Precision CV	< 1% (Coefficient of variation CV)
Velocity range	1 - 6,000 rpm
Fluid connection	1/4"–28 UNF, frontal; optional: inlet 1/8" NPT internal thread, lateral
Wetted parts	stainless steel 316L (1.4404, 1.4435), tungsten carbide Ni-based; shaft seal: graphite-reinforced PTFE, 316L static seals: FPM, optional: EPDM, FFPM
Motor	DC-servomotor, 24 V DC, 44 W
Controller	integrated 16-bit, microcontroller
Interface	0-10 V, RS-232, 1 digital input/output
Dimensions (L x W x H)	140 x 45 x 65mm
Weight	approx. 780g
Remarks	*depending on accessories, Customized solutions on request.

Notice

Even if single parameters are within the indicated performance range of technical data, certain parameter combinations may not be achievable. Single parameters may exceed their indicated performance range under adequate circumstances. For detailed evaluation please contact HNP Mikrosysteme. Actual performance may vary. Specifications are subject to change without notice.

Accessories

- Reduction gear
- Heat insulation module
- Double shell heating module
- Reservoir Plastic
- Electrical heating module
- mZr-Touch Control

Dimensions

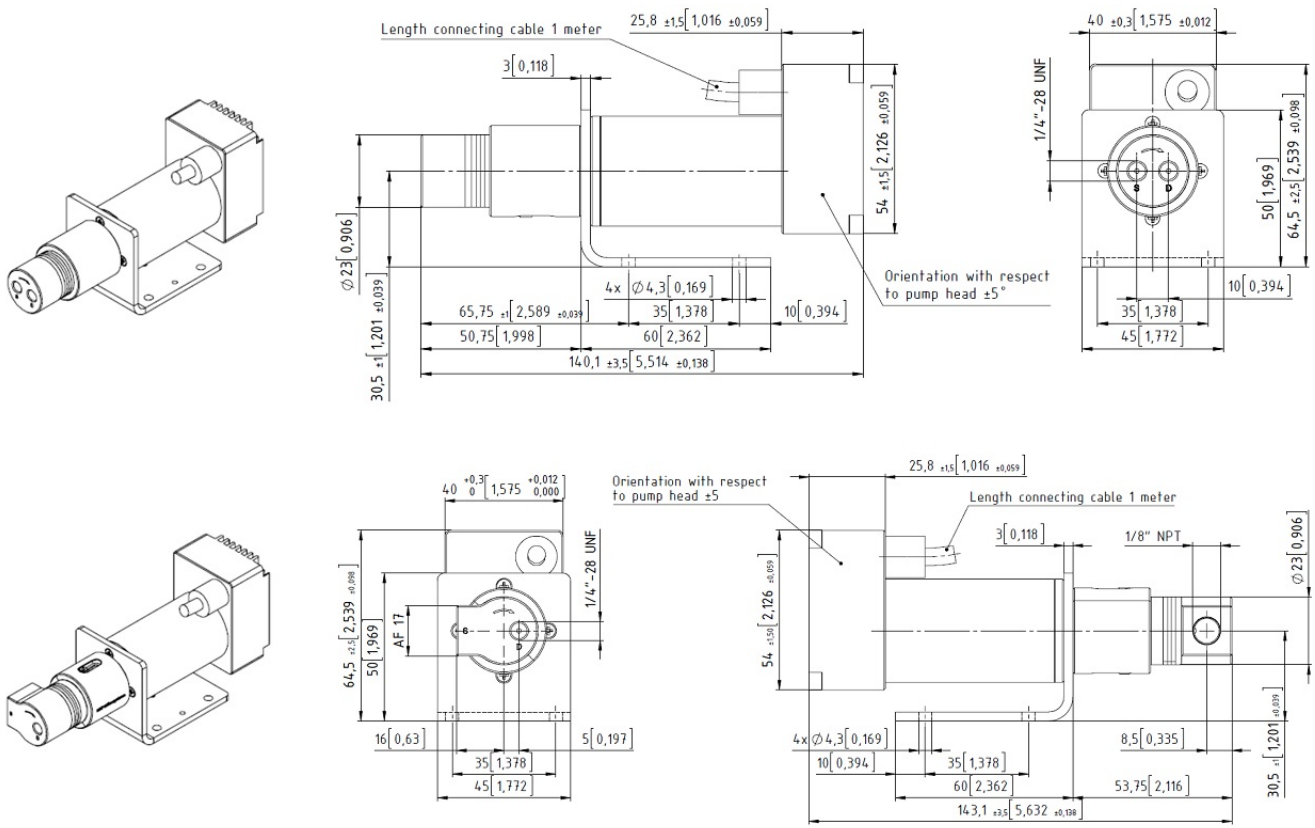

Flow charts

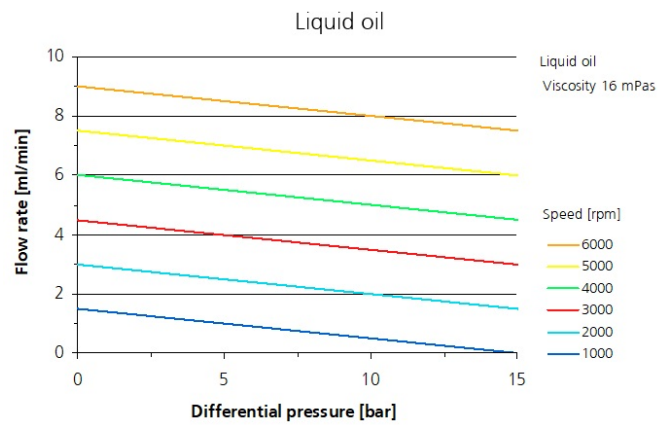
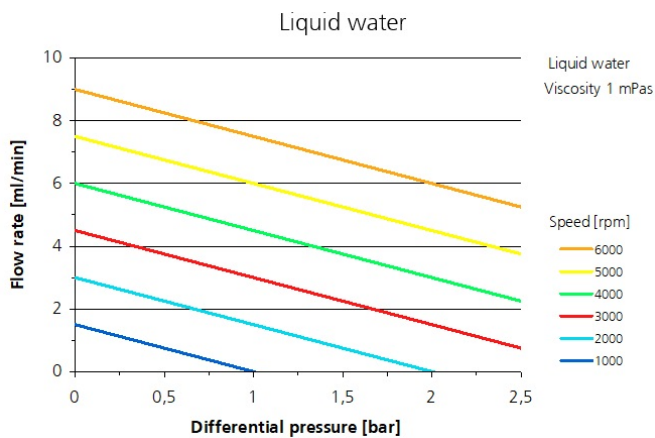

Patents and trademarks

Micro annular gear pumps (and housings) are protected by assigned patents: EP 1 354 135 B1; US 7,698,818 B2; DE 10 2011 001 041 B4; CN 103 348 141 B; US 10,012,220 B2; CN 103 732 921 B; US 9,404,492 B2; US 6,520,757 B1.
HNPM[®], mzr[®], MoDoS[®], μ -Clamp[®], μ Dispense[®], Centifluidic Technologies[®], LiquiDoS[®], smartDoS[®], ColorDoS[®] are registered German trademarks of HNP Mikrosysteme GmbH.

Contact

HNP Mikrosysteme GmbH
Bleicherufer 25
19053 Schwerin
Germany

T +49 385 52190-300
F +49 385 52190-333
info@hnp-mikrosysteme.de

Last update 2019/08