

## Modular pump series

### Micro annular gear pump mZR®-2542

#### Resistant customized dosing pump



- **Chemically inert materials**  
pump components in ceramics, tungsten carbide, alloy C276, alloy C22, PEEK™
- **High dosage precision**  
precision CV 1% at low volumes
- **Long service life**  
wear-resistant, ultra hard materials
- **Compact dimensions**  
length 82 mm, diameter 16 mm
- **Dynamic smart drive and control**  
DC precision motor with integrated encoder
- **Pulseless delivery, low shear stress**  
rotary micro annular gear technology, no valves

The micro annular gear pump mZR-2542 of the modular series is suitable for dispensing and metering of aggressive or corrosive liquids. Equipped with oxide ceramic bearings, the material

configuration of the pump body as well as of the rotors can be individually selected. Depending on the nature of the delivered liquid, a choice of different resistant components allows a

customized configuration. The rotors are available in ZrO<sub>2</sub>-ceramics or in tungsten carbide. Alloy C276, alloy C22 and PEEK™ are the different housing options.

#### Applications

- Analytical technology
- Biotechnology
- Microreaction technology
- Laboratory automation

#### Technical data

Flow rate	0.15 – 9 ml/min (min. 0.0015 ml/min *)
Smallest dosage volume	0.25 µl
Displacement volume	1.5 µl
Differential pressure range	0 – 1.5 bar (22 psi)
Max. inlet pressure	1 bar (15 psi)
Pulsation	1.5 %
Operating temperature range	-20 ... +60 °C
Viscosity range	0.3 ... 100 mPas (max. 1000 mPas *)
Precision	1 % Coefficient of Variation CV
Speed	100 – 6000 rpm (min. 1 rpm *)
Fluid connection	slip fittings, outside diameter 2 mm optional: manifold assembly
Wetted parts	Alloy C276 (2.4819), alloy C22 (2.4602), optional: PEEK™; shaft ZrO <sub>2</sub> ceramics; rotors partially stabilized ZrO <sub>2</sub> ; epoxy resin; shaft seal: graphite-reinforced PTFE, alloy C276; static seals: FFPM, optional: FPM, EPDM
Motor	DC-motor with graphite brushes, assigned power rating 4.5 W, nominal voltage 24 V, digital magnet encoder 32 counts per turn
Electrical connection	10-pole connector
Measurements	diameter 16 mm, length 82 mm
Weight	approx. 70 g

Customized solutions on request.

\* with optional high resolution encoder, gear box

#### Contact

HNP Mikrosysteme GmbH  
Juri-Gagarin-Ring 4 · D-19370 Parchim

phone +49| 3871| 451-301  
fax +49| 3871| 451-333

e-mail info@hnp-mikrosysteme.de  
http://www.hnp-mikrosysteme.de

## The Universal Pump

Showing an almost universal chemical resistance, an excellent service life and a compact design this modular mzm-pump is applicable for fast, precise dosing tasks in the micro volume range.

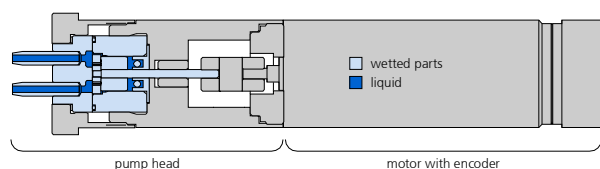

## The Modular Principle

It is necessary to select carefully the configuration of the wetted components of a pump for each given application. This is due to the fact that the construction materials are not equally suitable for all the liquids. Consequently, the possibility of a flexible combination of the functional parts from different materials increases the application scope of a pump. The »modular series of micro annular gear pumps« offers exactly this solution, as the individual components from different materials can be variably combined. Due to simple and small geometry of the wetted pump parts, the use of challenging construction materials was made possible. The table below shows the available individual components of the modular system.

## Materials

For an adequate selection as to the chemical resistance of the materials, different component configurations are briefly described in the following paragraphs. The final configuration of a pump should be defined after an exact examination and selection.

The employed oxide ceramics  $Al_2O_3$ ,  $ZrO_2$  and the  $Al_2O_3$  stabilized with  $ZrO_2$  are, as far as the application in pumps is concerned, optimal construction materials, since the corrosion resistance, the mechanical characteristics such as wear resistance or hardness, the finish machining as well as the price are in an optimal relationship. Due to its high purity, ceramics can be used both with acid and alkaline liquids, water or solvents. The densely sintered ox-

ide ceramics suits medical or biotechnological applications.

As nickel chrome molybdenum tungsten alloy C276 (2.4819) offers a particularly high stability for the bearing case, which supports the ceramic bearings of the pump and is wetted by aggressive, oxidizing and reducing media.

With PEEK™ a part-crystalline thermoplastic polymer can be chosen for the bearing case, where an excellent chemical resistance to virtually all commonly used solvents is required. Polyetheretherketone features an outstanding stability in a broad spectrum of organic and inorganic liquids.

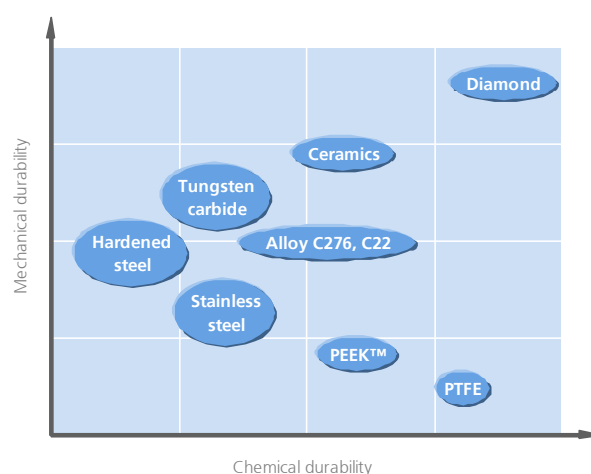

As seal materials for the static O-ring seals FPM, EPDM or FFPM can be selected. The examination and correct selection of the elastomer with consideration to its liquid compatibility is particularly important.

Variation of materials	mzm-2542-cy	mzm-2542-hy	mzm-2542-cp	Additional materials
Rotors	Partially stabilized $ZrO_2$	Tungsten carbide Ni-based	Partially stabilized $ZrO_2$	Diamond-tungsten carbide*
Bearing case	Alloy C276 (2.4819)	Alloy C276 (2.4819)	PEEK™	316L, Titanium Grade 2
Dynamic seal	Graphite-reinforced PTFE spring alloy C276	Graphite-reinforced PTFE spring alloy C276	Graphite-reinforced PTFE	UHMWPE spring by arrangement
Shaft	$ZrO_2$ -ceramics	$ZrO_2$ -ceramics	$ZrO_2$ -ceramics	Tungsten carbide Ni-based
Fluid connections	Alloy C22 (2.4602)	Alloy C22 (2.4602)	PEEK™	316L, Titanium Grade 2
Static seals	FFPM	FFPM	FFPM	FPM, EPDM

\* under development

## The Standard Variants

In order to facilitate the selection as well as to shorten the delivery time, three standard variants of the modular micro annular gear pump are offered.

The **mzr-2542-cy**, configured with an alloy C276 bearing case material and rotors made of oxide ceramics, forms a high corrosion-resistant dosing pump. The pump can be used both in acid and alkaline environments and be applied, among other, for buffers and aggressive solvents. This pump is available with slip fittings and in a manifold version.

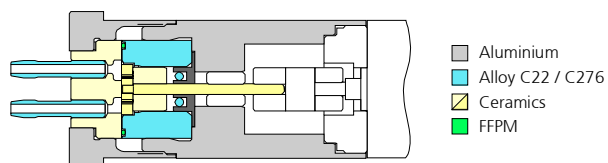

The **mzr-2542-hy**, configured with an alloy C276 bearing case material and rotors made of tungsten carbide, forms a corrosion-resistant dosing pump. It offers a high resistance to alkaline liquids and saline solutions. This pump is available with slip fittings and in a manifold version.

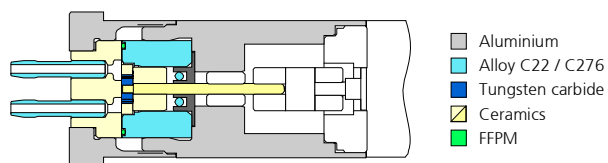

The **mzr-2542-cp** can be used in applications in which the absence of metals is required for example in biology and biochemistry. Its rotors are made of oxide ceramics and the bearing case is machined from PEEK™. This pump is available only in a manifold version.

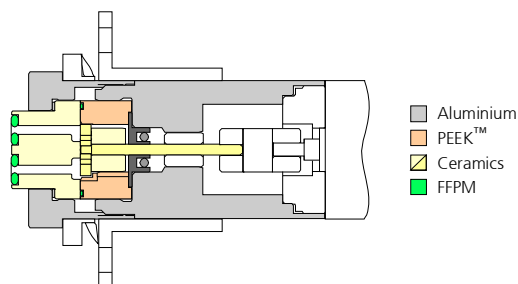

## Design and Interface

For all pumps oxide ceramics is used as material for the rotor and shaft bearings. Thereby all radial and axial bearing functions are implemented in ceramics. The rotor bearing is bound to the bearing case with an epoxy adhesive.

All pumps are equipped with a high performance DC precision motor with integrated encoder. All pumps having the same appearance, the pump case is manufactured with anodized aluminum. The individual configuration of each pump can be distinguished thanks to the identification plate.

Micro annular gear pumps of the modular series have an extremely long-term stable, self adjusting rotary shaft seal, which consists of a graphite-reinforced PTFE with an inserted spiral spring. The experience shows that rotatory working seals feature smaller wear than translatory working seals, used with linear pumps. Consequently, a long lifetime is guaranteed. For special applications, the use of a FDA-certified ultrahigh molecular polyethylene is possible.

The design of the precision coupling system is identical for the entire pump series, where an elastomer cross leads to a minimal misalignment and a minimal angle error. Therefore long-term tightness and long service life are ensured.

The fluid interface of the pump consists alternatively of slip fittings or a manifold assembly for a simple handling and exchange. For the slip fitting assembly clamps can be supplied for a safer connection. The manifold assembly is recommended for a low dead-volume assembly.

## Measurements

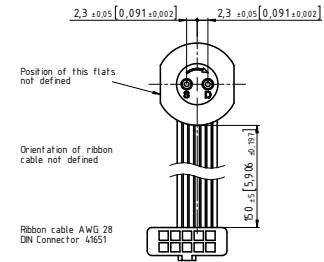
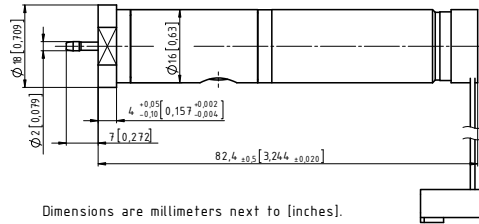
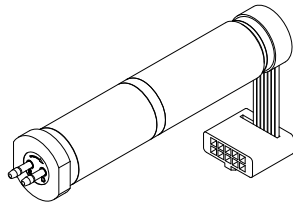

Configuration with slip fittings OD 2 mm

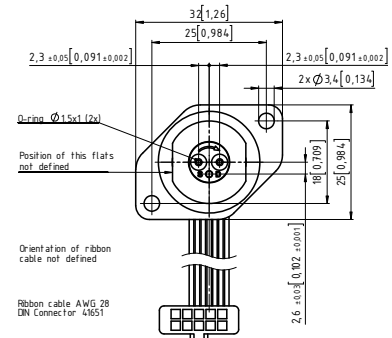
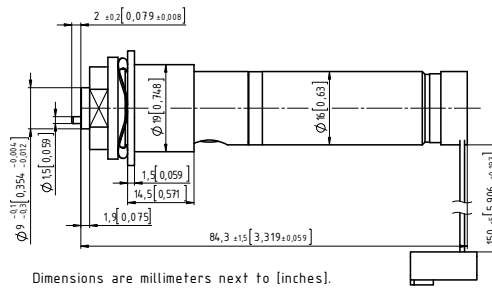
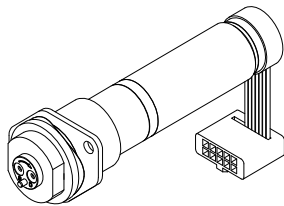

Configuration with manifold assembly M2.1

Subject to technical changes.

## Flow charts

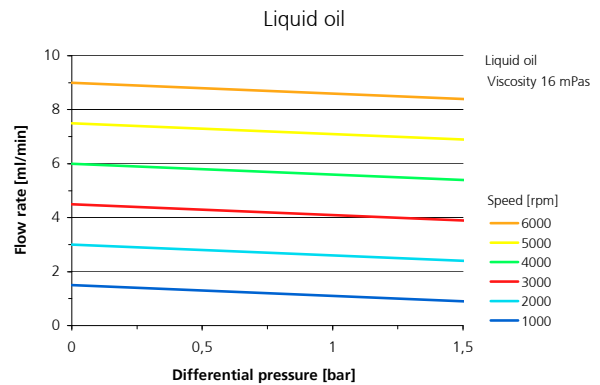
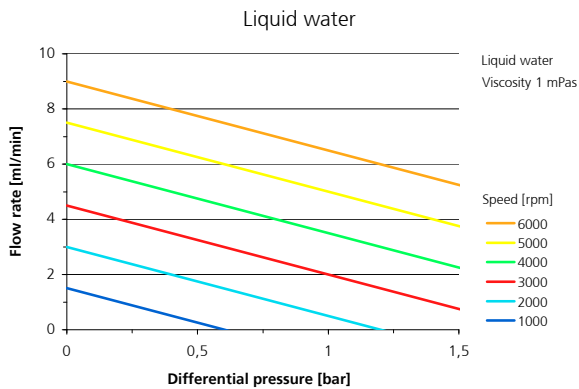

## Item number

12 01 00 04	micro annular gear pump mZR-2542-cy with DC-motor, bearing case alloy C276, rotors ZrO <sub>2</sub> , slip fittings
12 01 00 01	micro annular gear pump mZR-2542-hy with DC-motor, bearing case alloy C276, rotors tungsten carbide Ni-based, slip fittings
12 01 00 08	micro annular gear pump mZR-2542-cp M2.1 with DC-motor, bearing case PEEK™, rotors ZrO <sub>2</sub> , manifold assembly

## Accessories

Liquid supply accessories

Control

Console drive module

Multiplexer module

tubes, filters etc.

S-KG-22: control for continuous delivery

S-ND: programmable microcontroller-based control for continuous delivery and discrete dosage

diecast aluminum chassis mZR-S06 and mZR-S06E for laboratory and testing

simultaneous operation of up to 255 pumps with a single RS-232 interface

Micro annular gear pumps (and housings) are protected by assigned patents: DE 198 43 161 C2, EP 1115979 B1, US 6,520,757 B1, EP 852674 B1, US 6,179,596 B1, EP 1354135, US 7,698,818 B2. Patents pending: EP 1807546, DE 10 2009 020 942.5-24, DE 10 2011 001 041.6. In the US, Europe and Japan additional patents are pending. mZR®, MoDoS®, µ-Clamp® are registered German trademarks of HNP Mikrosysteme GmbH. PEEK™ is a registered trademark of Victrex plc.